

Jacuzzi™

BATH

CATÁLOGO GENERAL 2024

COD29072024

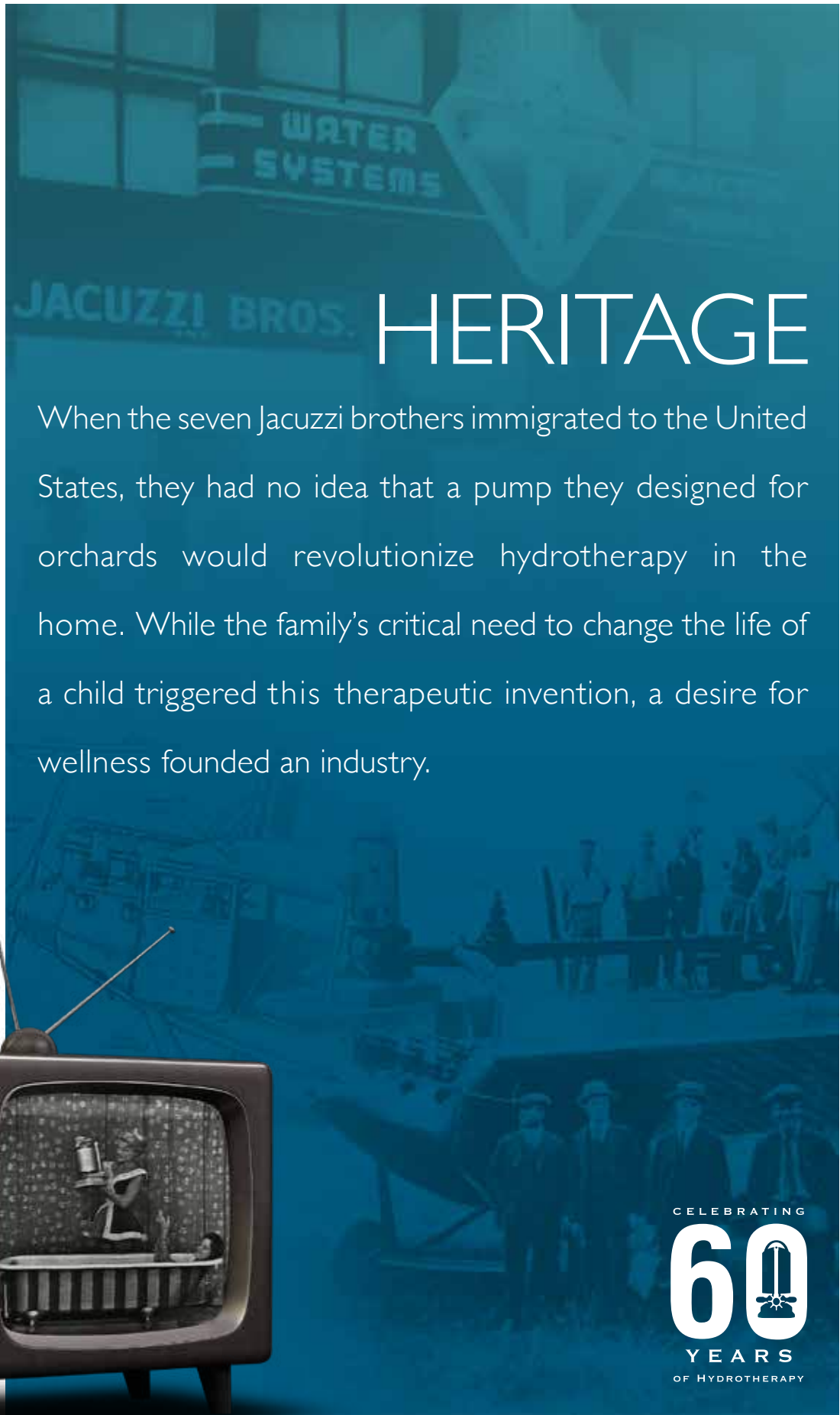

HERITAGE

When the seven Jacuzzi brothers immigrated to the United States, they had no idea that a pump they designed for orchards would revolutionize hydrotherapy in the home. While the family's critical need to change the life of a child triggered this therapeutic invention, a desire for wellness founded an industry.



CELEBRATING

60

YEARS

OF HYDROTHERAPY



Baths



Showers



Hot Tubs



Swim Spas



Saunas



Commercial

Jacuzzi® Brand products are manufactured in 5 countries, enjoyed in more than 100 countries worldwide, and employ thousands of people around the world. Representing decades of innovation, design, performance and ease of use, the Jacuzzi® Brand is trusted by millions of customers globally.

WELL-BEING

From the beginning, our focus has always been on improving the quality of life for the people around us. Committed to designing ways to help you build a retreat at home, we give you the power to find serenity exactly when you need it, each and every day.

Some of the smallest habits you love to do can be more beneficial than you realize. As simple as enjoying a cup of coffee, daily rituals can increase your quality of life. Incorporating well-being products into your routine can have the power to foster an increased level of health, happiness, vitality, and spirit in your own home.

With experiences that include Soaking, Heated Soak, Whirlpool, Swirlpool™, Salon® Spa, and Pure Air® Bath, luxury shower systems and beautifully crafted sinks and medicine cabinets, you can nurture both body and mind with a spa-like sanctuary that complements your lifestyle.

As we develop and design the products that enhance your life every day, Jacuzzi will continue to shape well-being around the world.



Hydrotherapy

(The therapeutic use of water)

Jacuzzi® bathtubs are ergonomically designed to maximize the benefits of hydrotherapy, allowing people of all body types to fully immerse in warm water.

Benefits of a Full-Body Soak:

1. Relieves the weight of gravity on joints
2. Provides 360-degree support for sore and tired limbs
3. Decreases swelling and inflammation
4. Increases circulation and oxygen in blood cells

Why soaking makes you feel better

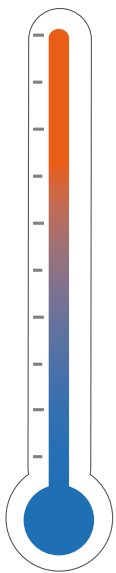

- Up to 104°F - Hot water**
Relaxing, promotes sleep by inducing drowsiness
- 93°F - 100°F - Water at body temperature**
Reduces tension, adding Epsom salt facilitates sweating to cleanse the skin and help eliminate lactic acid
- 81°F - 92°F - Lukewarm water**
Helps eliminate water retention
- 65°F - 81°F - Cool water**
Alleviates fatigue
- Below 65°F - Cold water**
Aids muscle recovery from physical exertion

Pure Air® Bath adds soothing bubbles to your soak



Thermal Lumbar Comfort™ (TLC) air injectors target relief to the lower lumbar area, a common trouble spot. TLC is a unique part of the Pure Air® bath experience.

Hydromassage

(Moving water for the optimal massage)



What makes Jacuzzi® hydromassage effective

Gentle pressure on muscle tissue increases circulation. This stimulates blood flow, which can help muscles and joints recover from fatigue or injury, and makes it easier to move.

The exclusive, patented TargetPro™ jetting offers adjustable jet stream direction and intensity for a personalized massage experience.

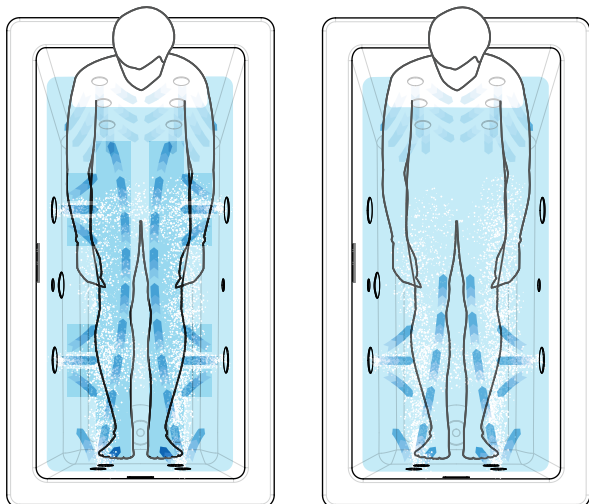

Hydromassage soothes fatigue

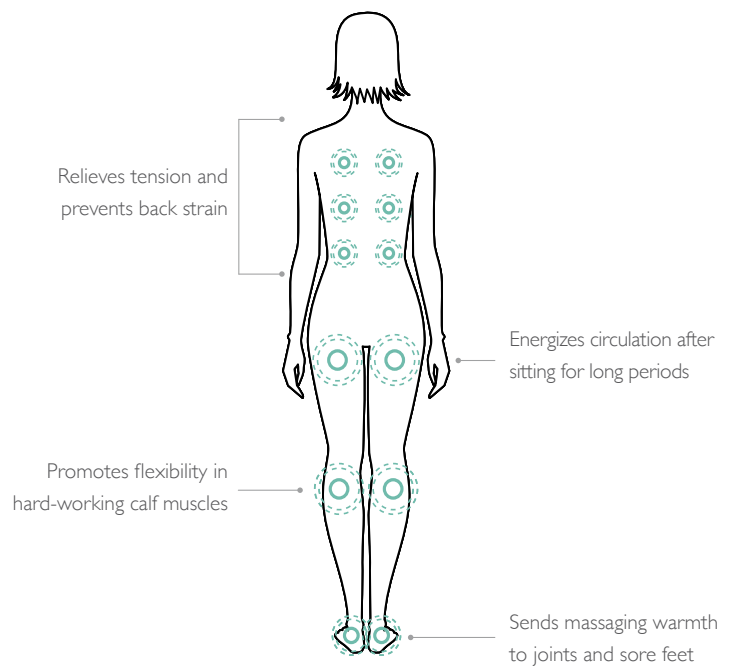

WHERE TO START - BATHTUB OPTIONS

Installation Methods



FREESTANDING



DROP-IN



UNDERMOUNT



SKIRTED/ALCOVE

Bathing Experiences



NEW EXPERIENCE

SP

Shown with Jacuzzi® Colored Epsom Salt

SWIRLPOOL™ BATH

The Swirlpool™ Bath Jets move the water in a circular motion without air infusion, allowing for the calmest form of hydromassage.

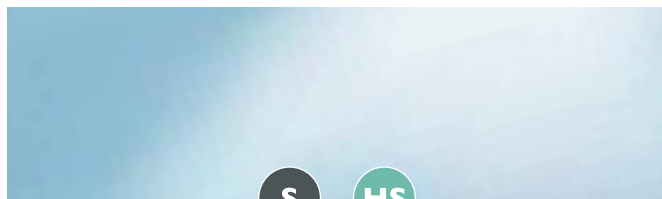

S HS

SOAK/HEATED SOAK

Indulge in the fundamental form of hydrotherapy (Soak) longer by circulating warm water continuously (Heated Soak).

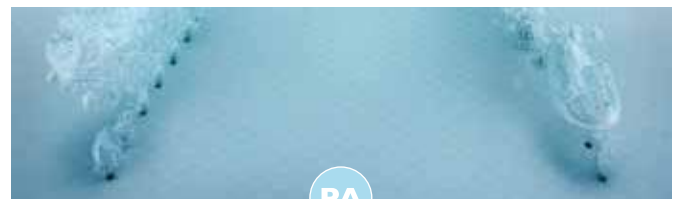

PA

PURE AIR® BATH

Small bubbles of air in warm water create a revitalizing effect.



WP

WHIRLPOOL

Jacuzzi® jet systems push high volumes of water uniquely mixed with air into a hydromassage bath.

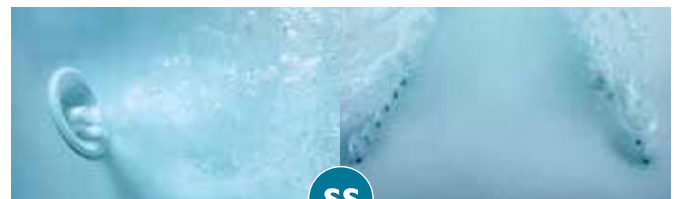

SS

SALON® SPA

Whirlpool and Pure Air® combined for the ultimate, highly-customizable hydromassage experience.

KEY FEATURES

Our Jets

JACUZZI® AQUALIBRIUM®

A perfect balance of air and water is vitally important to the quality of any whirlpool system.

PATENTED TARGETPRO™ DIFFERENCE

A jetted water stream that draws air 360° from its outer edges to its core, delivering a powerful massage without being overly aggressive. Jacuzzi® jets maintain an optimal mix of air and water to deliver a relaxing high-flow, low-pressure massage.

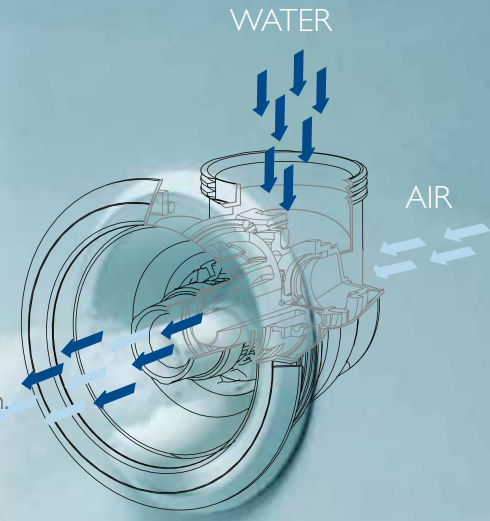

TargetPro™ Jet

Featured Jets



ROTATING NECK JET

- Exclusive Jacuzzi® jet
- Highest flow spinner in the industry
- Ideal for shoulder and neck massage



ACCUPRO™ AND THERAPRO™ JETS

- Adjustable flow and direction
- Accurately targets back and feet



POINTPRO™ JET

- Adjustable flow and direction
- Use air controls to choose a gentle or invigorating massage



SLIMPRO™ AND SLIMPRO™ MINI JETS

- Ultra-low profile for added comfort
- Offered in multiple finishes



TARGETPRO™ JET

- Patented Jacuzzi® exclusive
- 60° adjustability
- Available with Illumatherapy® lighting



SWIRLPOOL™ JET

- Exclusive Jacuzzi® jet
- Clean look, flush with the surface of the bathtub
- Features Illumatherapy® lighting
- Indirect hydromassage

CleanLine® System: Engineered to Provide a Cleaner Bathing Experience

Standard on Jacuzzi® Jetted Bath Experiences

CLEANLINE® TECHNOLOGY

Anti-microbial additives are standard in all water lines in Heated Soak, Whirlpool, Swirlpool™ and Salon® Spa bathtubs.

NON-POROUS ACRYLIC SIMPLIFIES CLEANING

The non-porous characteristic of acrylic defends against penetration of microorganisms into the surface.

AUTO-DRI™ FEATURE

The pre-programmed Auto-Dri™ feature drives excess water from air lines in Salon® Spa and Pure Air® bathtubs.

DRAIN-DOWN PLUMBING

Drain-down plumbing in Salon® Spa, Pure Air®, Whirlpool, Swirlpool™ and Heated Soak baths helps properly drain water lines.

SYSTEMS CLEAN™ JETTED BATH CLEANER

Systems Clean™ jetted bath cleaner can be used to quickly deep clean, sanitize and deodorize Heated Soak, Whirlpool, Swirlpool™ and Salon® Spa baths.



OUR MATERIALS

Solid Surface

Using our premium Luxecast® composite material, containing minerals derived from natural stone, we have created more sophisticated and imaginative designs in bathtubs and sinks than ever before.



Rosalia® Bathtub and Sink



Look for the Solid Surface icon where available on bathtubs.



MATTE WHITE



GLOSS WHITE

Acrylic

Strong and durable, acrylic Jacuzzi® bathtubs are reinforced with a proprietary fiberglass/resin formula that ensures a long-lasting quality surface.



Luna® Bathtub



MATTE WHITE
*Only available in Arga™, Arga™ Classic and Luna®



OYSTER



WHITE



BLACK

UPGRADE THE EXPERIENCE

Lighting

Chromatherapy is the use of color and light to restore balance and well-being.

CHROMATHERAPY



Jacuzzi® Chromatherapy features LED lighting through one or two wall-mounted lenses, echoing the colors in nature that come from light.

On select Fuzion® models and the Elara® Plus, Chromatherapy is available as a lighted neck-massaging waterfall.

ILLUMATHERAPY®



The exclusive technology of LED Illumatherapy® makes color and light sparkle throughout the bathing well from within four patented TargetPro™ jets. Also included with Swirlpool™ jets.

Bathtub Controls

The Jacuzzi® Brand took the industry lead by making sophisticated electronic controls a standard feature. Intuitive design makes Jacuzzi® bathtub controls easy to use.

J6 Glass Touch



- Illuminated glass touch control
- Activates jets, lights and waterfall
- Pivots to reveal salt mixing chamber
- Exclusive to Arga™ Collection

Upgrade: J5 LCD



- Programmable full-color LCD screen
- Personalize your bathing experience even more
- Use quick-start menu or store your preferences in memory

J4 Electronic



- Scroll through colors and dim lights
- Push-button wave action
- Responsive LED indicators
- Control jet and air volume

J2 Electronic



- Scroll through colors and dim lights
- Adjust air volume (Pure Air® only)

Whisper+ Technology

Our quietest jetted experience of all, a brushless motor mounted on the Whisper vibration-absorbing base reduces noise and vibration up to **66%** while using **60%** less energy and transferring heat back into the water.*

Whisper Technology®

A vibration-absorbing mount allows you to enjoy the benefits of a jetted bath with less noise and vibration.

*Based on results at a third party test facility. Elara® standard 120v Whirlpool bath with heater vs. Elara® Whisper+ Technology® 120v Whirlpool bath.

Jacuzzi® Epsom Salt Compatible

Jacuzzi® Soaking and Swirlpool™ bathtubs, as well as Whirlpool bathtubs with Whisper+ Technology® are Jacuzzi® Epsom salt compatible.

Recover from physical activity, soothe sore muscles, ease aches and pains, soften skin and relieve stress.



Jacuzzi® Epsom Salt
Compatible



BEHIND THE SCENES

Why a Jacuzzi® Bathtub is the Right Choice

TLC

Thermal Lumbar Comfort™ curved air injectors target lower back and relieve tense muscles



AUTO-DRI™ FEATURE

Automatically drives lingering water out of airways

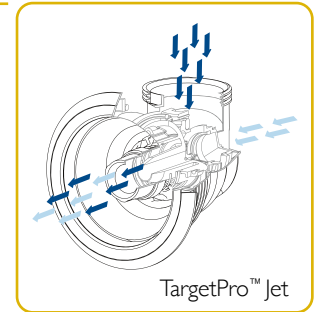

WHISPER TECHNOLOGY®

Reduces noise and vibration for a quieter experience



Up to 66% less noise and vibration than other whirlpool baths

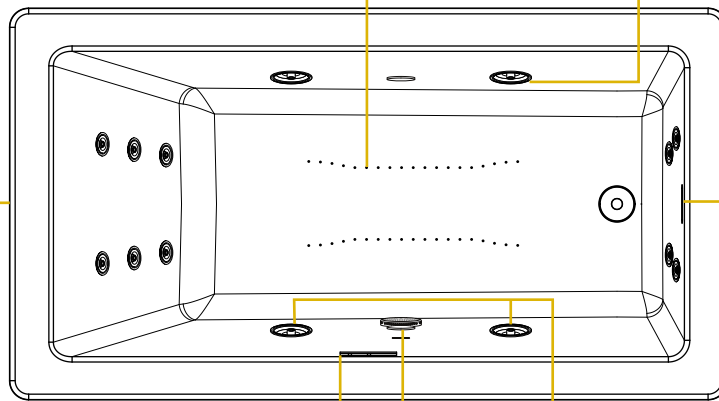

LINEAR OVERFLOW DRAIN

Allows for a deeper soak and adds a polished, modern aesthetic

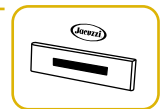

CONTROL PANEL

Electronic controls are standard on all Jacuzzi® experience bathtubs

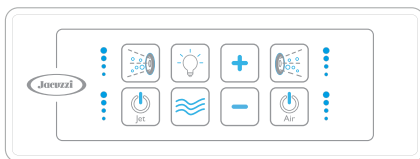

CHROMATHERAPY

Provides unique, multi-color LED lighting to set the ambiance



ILLUMATHERAPY® FEATURE

TargetPro™ and Swirlpool™ jets add an even glow of light combined with jetted water for a serene effect



Illustrations are based on the ELARA® Salon® Spa.
Not all features are available on all models.

JACUZZI® EPSOM SALT COMPATIBLE

OPTIONAL

Our experienced engineers and technicians continue to develop new products that are backed by the latest research in science and technology, from the materials used for construction to the demonstrated positive effects of hydrotherapy. The exclusive Jacuzzi® warranty is your assurance of quality.

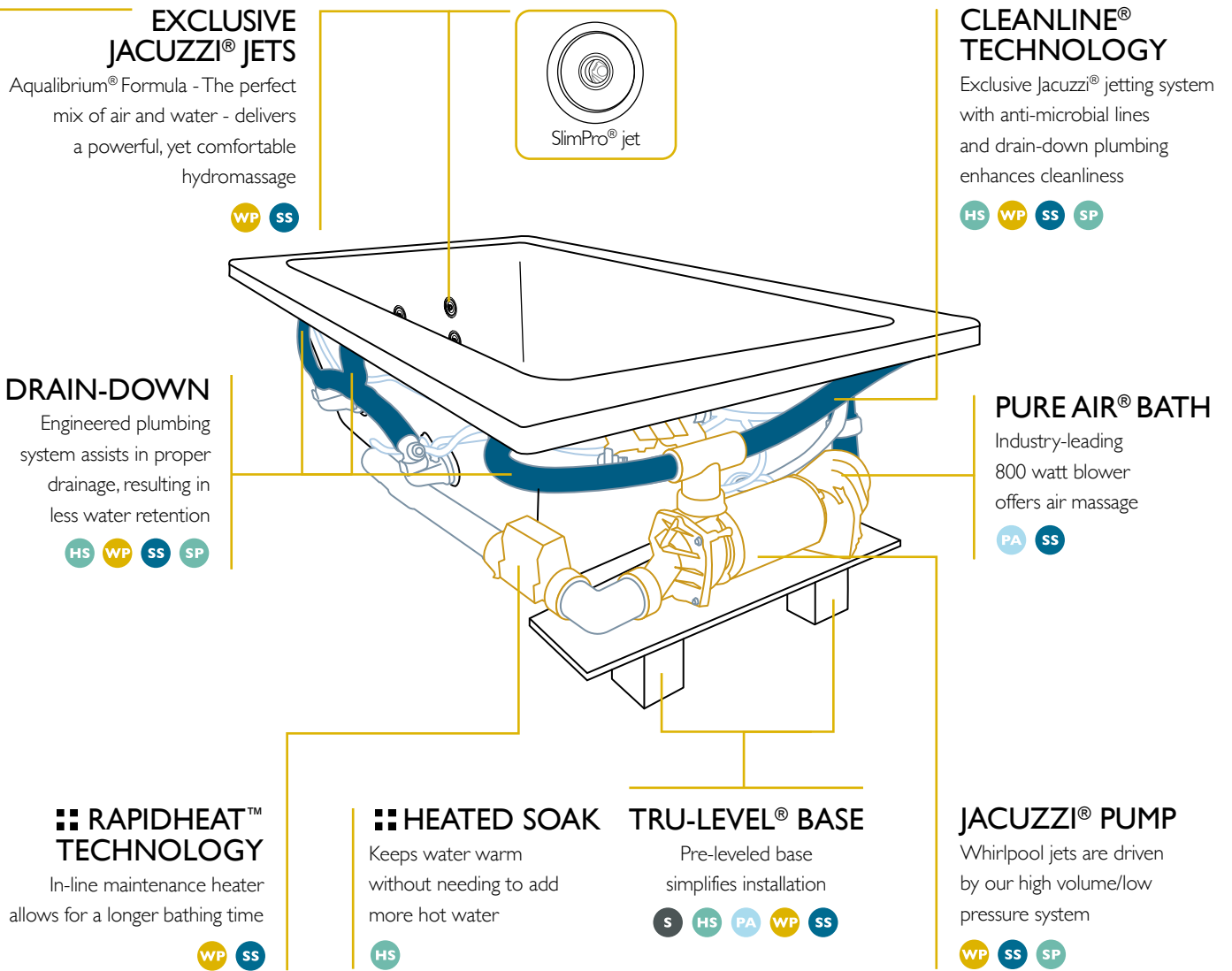

AMALIA™

The Amalia™ bathtub is diligent by name and by design. Its soft ledge serves multiple purposes, including filler mounting capability. Or simply use the space to rest bathing essentials.

FREESTANDING | CENTER DRAIN

59"L × 32"W × 23.5"H

67"L × 34"W × 24"H

BATHING DEPTH

17-17.6"

S



Amalia™ 59" Bathtub shown with Piccolo™ Roman Tub Filler and Widespread Faucet

ARGA™

REESTANDING | CENTER DRAIN
69"L × 34"W × 22"H

Sculpted with a contemporary appeal and a proprietary salt mixing chamber; the mineral-rich waterfall and unique Swirlpool™ jets set the stage for a multisensory experience. Hear the calming waterfall; see the swirl envelop you; feel the warm water as the Epsom salt releases your tension; smell the rosemary mint. Indulgence starts here.

BATHING DEPTH
13.75"



NEW EXPERIENCE WITH INTEGRATED EPSOM SALT INFUSER

Whisper+
UPGRADE INCLUDED

Shown with Contento® Tub Filler and Jacuzzi® Bathtub/Shower Shelf

ARGA™ CLASSIC

FREESTANDING | CENTER DRAIN
67"L × 35"W × 26"H

BATHING DEPTH
16.5"

Showcasing a timeless aesthetic, the Arga™ Classic delivers a unique bathing experience. The proprietary, integrated salt infuser and Swirlpool™ jets mix the salt into the water in a circular motion for a stunning visual effect. This exclusive system comes standard with Illumatherapy® lighting and is powered by Whisper+ Technology®, allowing you to only hear the peaceful sound of the slow-moving stream. Indulge today.



NEW EXPERIENCE WITH INTEGRATED EPSOM SALT INFUSER

Shown with Jacuzzi® Epsom Salt

Whisper+
UPGRADE INCLUDED

BIANCA®

The Bianca® freestanding bathtub is available in the Soaking, Heated Soak and Whirlpool experiences. The Bianca® bathtub delivers Jacuzzi® hydrotherapy in a revolutionary self-contained design. Its generous 18.5-inch soaking depth is ideal for the Heated Soak experience which keeps the water warm without adding more.



FREESTANDING | UNIVERSAL END DRAIN
66"L × 36"W × 24"H

BATHING DEPTH
18.5"



BUNDLE AVAILABLE
with Contento® Filler



Whisper+
UPGRADE INCLUDED

Shown with Jacuzzi® Contemporary Square Filler

CELESTE™

The architectural look of the Celeste™ Soaking bathtub is the design equivalent of the soaking experience itself – original, timeless and sensuous. The Celeste™ bathtub, or heavenly in Italian, is available in white acrylic with either a white or chrome integral overflow drain kit.

FREESTANDING | CENTER DRAIN

59"L × 31.5"W × 23.3"H

67"L × 31.5"W × 23.3"H

70"L × 32"W × 23"H

BATHING DEPTH

14.5" - 15.5"



BUNDLE AVAILABLE
with Contento® Filler



Shown with Jacuzzi® Transitional Round Filler and Jacuzzi® Triple Door Medicine Cabinet

CETRA®

Take your time exploring the Cetra® bathtub. It works in skirted or drop-in settings, and features supportive, built-in armrests.

DROP-IN | END DRAIN

60"L × 32"W × 21.25"H

60"L × 36"W × 21.25"H

SKIRTED | END DRAIN

60"L × 32"W × 20.5"H

60"L × 36"W × 21.25"H



ELARA®

The Elara® has chameleon qualities, fitting beautifully into any drop-in installation, including a customized flush-mount setting. You'll adapt to the Jacuzzi® experience, too, easily morphing from stress to serenity as you lie back on the flush SlimPro® jets. The Heated Soak experience keeps the water warm as you bathe.



DROP-IN OR UNDERMOUNT | END DRAIN

60"L × 42"W × 26"H

66"L × 36"W × 26"H

72"L × 36"W × 26"H

72"L × 42"W × 26"H

LOW PROFILE

DROP-IN OR UNDERMOUNT | END DRAIN

60"L × 32"W × 19.5"H

60"L × 36"W × 22.5"H

66"L × 36"W × 22.5"H



Whisper+

UPGRADE AVAILABLE

ELARA[®] PLUS

DROP-IN OR UNDERMOUNT | CENTER DRAIN
79"L × 59"W × 25.5"H

The Elara[®] Plus delivers wellness with quiet elegance, providing the flexibility to adapt your bathing experience to your specific wellness needs. Three unique massage seats boasting a total of 28 whirlpool jets bring the benefits of a hydrotherapy circuit experience into your home.



Whisper⁺
UPGRADE INCLUDED

Shown with Water Rainbow[®] Flow Tub Filler

FUZION®

Dramatic in any setting, the true beauty of the Fuzion® bathtub comes from experiencing authentic Jacuzzi® hydrotherapy. With a total of 23 jets in this Dual Zone Whirlpool bath, the Fusion® bathtub allows for two people to each personalize their own unique hydromassage at the same time.

DROP-IN OR UNDERMOUNT | CENTER DRAIN

70.8"L × 35.5"W × 24"H* (END DRAIN ONLY)

72"L × 42"W × 24"H

71.8"L × 59.8"W × 24"H

71.8"L × 59.8"W × 24"H dual zone

65.8"L × 65.8"W × 24"H



Shown with Water Rainbow® Flow Tub Filler

INIZIO™

FREESTANDING | CENTER DRAIN
66"L × 36"W × 24"H

The beautifully balanced, freestanding Inizio™ bathtub is now also available in the whirlpool experience with six PointPro® jets and standard Whisper+ Technology® for a quiet hydromassage. Available as a bundle with the Transitional Round Freestanding Filler:



BUNDLE AVAILABLE
with Round Filler



Shown with Transitional Round Tub Filler and Bathtub/Shower Shelf

Whisper+
UPGRADE INCLUDED

STELLA®

Crisp lines softened by smooth curves distinguish the Stella® freestanding bathtub. The modern simplicity of the design includes a sleek integral linear overflow drain in white or chrome, and easy-care high-gloss acrylic material. Lean back against the contoured backrest and soak in the fundamental form of Jacuzzi® hydrotherapy.



FREESTANDING | UNIVERSAL END DRAIN

59"L × 30.4"W × 28.6"H

67"L × 31"W × 28.3"H

BATHING DEPTH

15" - 16"



BUNDLE AVAILABLE
with Contento® Filler

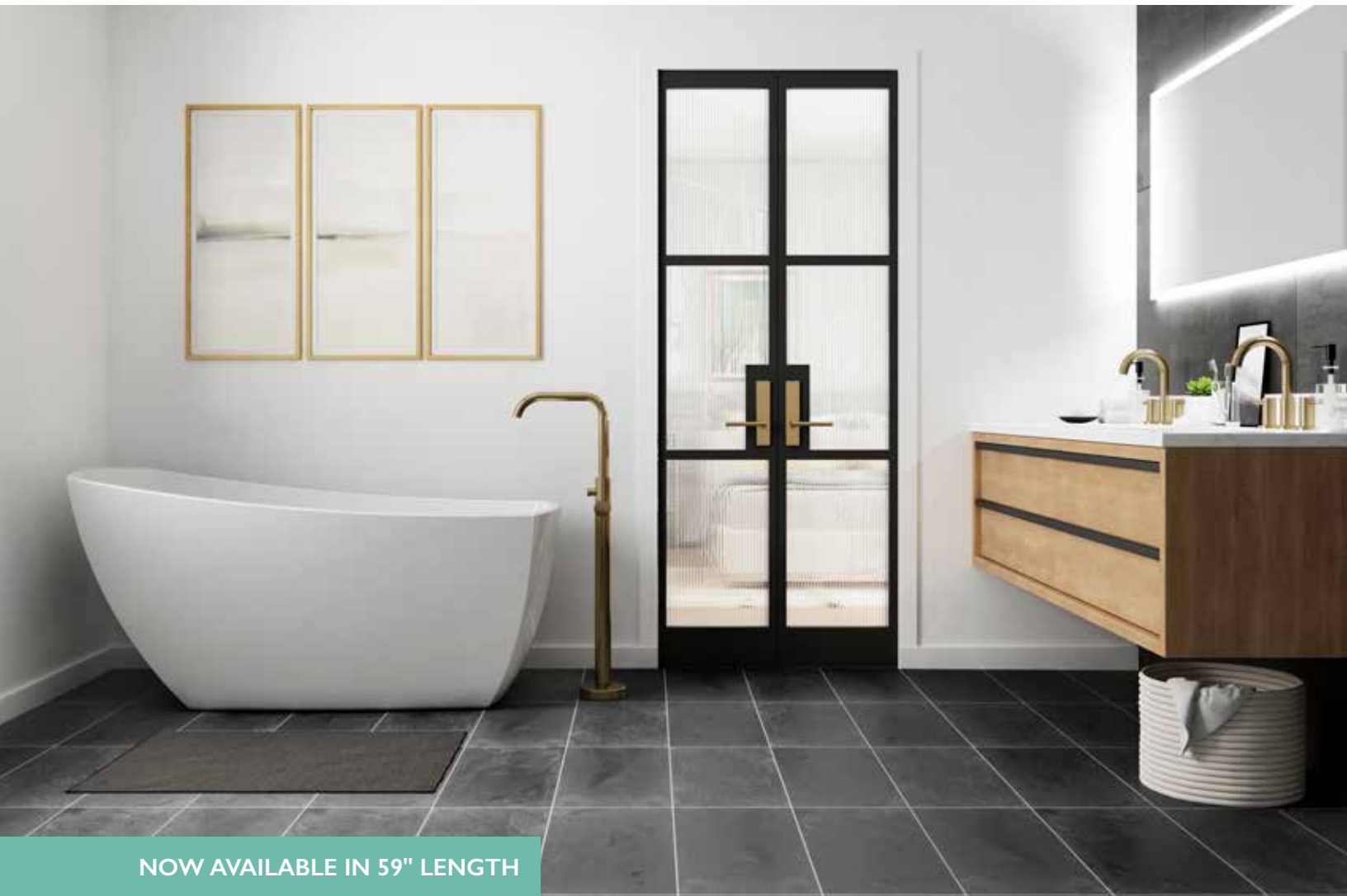

NOW AVAILABLE IN 59" LENGTH

Stella® 59" Bathtub shown with Contento® Tub Filler

SIGNATURE®

DROP-IN | END DRAIN



72"L × 36"W × 19.25"H





FAUCETS & ACCESSORIES

DRAINS & DRAIN KITS

AVAILABLE FINISHES

-  Polished chrome
-  Brushed nickel
-  Polished nickel

-  Oil-rubbed bronze
-  White
-  Bright brass

Note: Not all finishes are available for all drain kits. See price book for availability.



LINEAR OVERFLOW DRAIN KIT



ROTARY DRAIN PVC DRAIN KIT, 26" CABLE
(Without waste and overflow pipes)



ERA™ FREESTANDING TOE-TAP DRAIN KIT



UNIVERSAL ROTARY/CABLE DRAIN KIT, 26" CABLE



UNIVERSAL DEEP SOAK DRAIN KIT



SLIP COVER DRAIN KIT
(Compatible with all bathtubs that have standard round overflow cutouts)

Slip Cover Drain Kit in brushed nickel shown with Modena® Bathtub



BATHTUB/ SHOWER SHELF

Exclusive solid stainless steel design

DIMENSIONS

20"L × 4"W × 3"H

30"L × 4"W × 3"H

AVAILABLE FINISHES

 Polished chrome

 Matte black

 Brushed nickel



Shown with Modena® Bathtub and Transitional Round Filler



BATHTUB CADDY TRAY

AVAILABLE FINISHES

 Embossed banter

DIMENSIONS

7.38"L × 31.62"W × 5"H



*Refer to Spec Sheet for size compatibility with bathtubs

Shown with Cosi™ Bathtub and Transitional Round Tub Filler



LENIRE[®] LUXURY PILLOW

The Lenire[®] ultimate bathtub companion, Italian for soothe, is made with Technogel[®] that adapts to flat and curved surfaces.

AVAILABLE COLOR

 Translucent grey

SIZE

11" × 5.5"

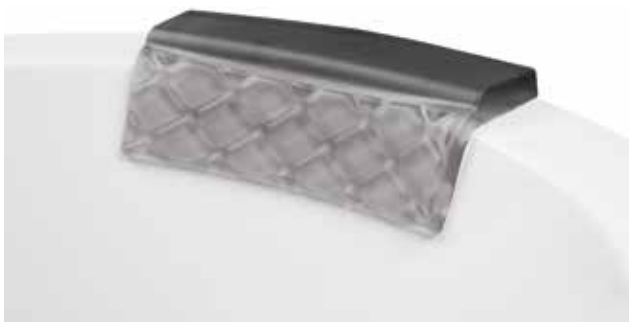

Shown with Fiore™ Bathtub



OPTIONS & ACCESSORIES

TILE FLANGE KIT

For easy install of a drop-in bathtub into an alcove installation.



JACUZZI® SYSTEMS CLEAN™ JETTED BATHTUB CLEANER

A two-part cleaner and deodorizer for all jetted bathtub plumbing systems.



JET RING TRIM KITS

Enhance the look of your bathtub with a simple change. Available finishes: Chrome, Brushed Nickel and Oil-rubbed Bronze.



Note: TargetPro™ jets with Illumatherapy® lighting come standard with acrylic-matched trim rings.

OPTIONAL HEATER UPGRADE

Available factory-installed on Whirlpool and Salon® Spa models to keep bath water warm.



DRAIN ALIGNMENT KIT

Simplifies the installation of freestanding bathtubs.



FUZION® REPLACEMENT PILLOW

20" x 5.2"



ERA™ BASES

Opt for claw feet for a traditional look or the pedestal base for less formal environments.



Pedestal base



WHITE ACRYLIC

Ball and claw feet



POLISHED CHROME



WHITE



BRUSHED NICKEL



BRIGHT BRASS

COLORS & FINISHES

ACRYLIC COLORS



WHITE



OYSTER



BLACK



MATTE WHITE*

LUXECAST® SOLID SURFACE FINISHES



GLOSS



MATTE

FAUCET & ACCESSORY FINISHES



POLISHED
CHROME



BRUSHED
NICKEL



POLISHED
NICKEL



MATTE
BLACK



OLIVE
BRONZE



OIL-RUBBED
BRONZE



WHITE



BRIGHT
BRASS



BRUSHED
BRONZE

See price book for detail on finish availability by item

*Only available in Arga™, Arga™ Classic and Luna™ Bathtubs

THE JACUZZI® BRAND HISTORY



**EARLY
1900s**

The seven Jacuzzi brothers emigrated from Italy to California. Hard-working inventors, they broke new ground in aviation and agricultural hydraulics.



1956

Brother Candido Jacuzzi developed the J-300 pump to provide pain-relieving hydrotherapy to his son, who suffered from arthritis.

1968

Third-generation Roy Jacuzzi designed the jetted bath, which was the first to incorporate jets into a bathtub, leading to family-sized bathtubs and eventually, the modern hot tub era.

2000

Jacuzzi® Brand bathtubs and hot tubs were sold in more than 75 countries, and new advancements emerged, including pump systems and jet technology.

2017

Launch of CleanLine® anti-microbial piping on all jetted products as well as Whisper+ Technology® for the quietest bath in the industry.



2019

Jacuzzi Luxury Bath expands offering into other bathroom categories, including fillers, faucets, sinks and medicine cabinets.

TODAY

Jacuzzi Luxury Bath introduces the Arga™ Collection, the first freestanding bathtubs that deliver the Swirlpool™ Experience and Epsom Salt delivery in the U.S.



📍 Oficinas Corporativas Artexa
Cañón Grande 7720, Col. La Estanzuela
Monterrey, N.L. 64984
T: (81) 8625 5000 info@artexa.com

📍 Artexa Experience & Design Center Mexico City
Homero 1433 Mezzanine Col. Polanco II Secc.
Delegación Miguel Hidalgo, Ciudad de México 11540
T: (81) 8625 5090 / 5091 citas@artexa.com

📍 Taller de Arquitectura Artexa
Rubén Darío 1533 Piso 6B
Col. Providencia Sección 4
C.P. 44639 Guadalajara, Jalisco.