



**CATÁLOGO 2025**

**COD-11022025**



REFRIGERADORES

BERTAZZONI	Código	Descripción	Color
	REF36DFIXNV	36" French door refrigerator - Freestanding - Stainless	Acero
	HK36MASFDX	Handles Kit Master Series 36" french door (901248)	Acero
	HK36PROFDX	Handles Kit Professional Series 36" french door (901249)	Acero
	HK36HERFDX	Handles Kit Heritage Series 36" french door (901250)	Acero
	DS2HERTSB	Black nickel decor set	Black nickel
	DS2HERTGO	Gold decor set	Gold
	DS2HERTPC	Copper decor set	Copper
<p><b>*Jaladeras no incluidas. Debe cotizarse equipo + jaladeras.</b></p>			
Especificaciones			
Size	36 in	Door storage	6 gallon sized bins
Volume	Ref 15.9 cu.ft / Frz 6.6 cu.ft	Ice maker	Automatic ice maker 3.08 lbs / 24h
Door finish	Stainless steel look	Settings	Super cool, Super freeze, Ice maker
User interface	Internal digital LED touch interface	Lighting	Top and sidewall LED lights
Refrigerator shelves	1 fixed and 4 height-adjustable, of which 1 retractable	Refrigerator crispers	1 large with preset temperature + 2 medium with adjustable humidity
Refrigerator freezer	2 drawers	Technical specifications	Electrical supply: 115 V 60 HZ - 190 W - 2.5 Amp Power connection: NEMA 5-15P with 67" power cord Sound rating: 45 dbA Water connection: 1/4" waterline with shut-o valve Water supply pressure: MIN 0.15 MPa (1.5 Bar, 21.32 PSI) MAX 0.83 MPa (8.3 Bar, 120.96 PSI) Certification: CEC,UL Warranty: 2 years parts & labor Packaging dimensions: W 38 3/16" H 72 7/16" D 30 9/16" Weight: 298.0 lbs



BERTAZZONI	Código	Descripción	Color
	REF36BMBZPNV	36 inch Bottom Mount Built-in Refrigerator Panel Ready with ice maker & internal water dispenser. Reversible door.	<b>Acero</b>
	PROHK36PI	Handle kit - Professional series for REF36BMBZPNV (cod. tecnico 901462)	
	MASHK36PI	Handle kit - Master series for REF36BMBZPNV (cod. tecnico 901463)	
	HERHK36P	Handle kit - Heritage series for REF36BMBZPNV (cod. tecnico 901509)	
	SP36BMX	Stainless steel door panels kit for REF36BMBZPNV (codigo tecnico 901609)	
	CTXV	Union Kit for 2 units of REF36BMBZPNV (codigo tecnico 901602)	
Especificaciones			
Size	36 in	Door storage	1 gallon sized + 2 height adjustable bins
Volume	Ref 14.2 cu.ft / Frz 5.6 cu.ft	Ice maker	Automatic ice maker 3.9 lbs / 24hrs
Door finish	Panel Ready	Settings	Super cool, Super freeze, Ice maker, Water filter replacement alarm. Water dispenser, Eco mode, vacation mode. Sabbath mode.
User interface	Internal digital LED touch interface		
Lighting	Top and sidewall LED lights		
Refrigerator shelves	1 stationary + 2 height-adjustable		
Refrigerator drawers	1 + 1 fresco drawer with separate temperature control	Technical specifications	
Freezer compartment	2 drawers	Electrical supply	115 V 60 HZ - 120 W - 3 Amp
		Power connection	NEMA 5-15P with 90" power cord
		Sound rating	43 dbA
		Water connection	1/4" waterline with shut-o valve
		Water supply pressure	25-80 psi (1.7-5.5 bar)
		Certification	ADA Compliant,CB,CEC,ETL
		Warranty	2 years parts & labor
		Packaging dimensions	W 38 3/16" H 90 9/16" D 26 3/8"
		Weight	417.0 lbs



BERTAZZONI	Código	Descripción	Color
	REF24BMBPNB	24" Bottom Mount integrated panel ready sliding door	White
	Especificaciones		
Worktop		Technical specifications	
Size	24 in	Voltage, Frequency, Amps	115 V 60 HZ - 85 W - 0.8 Amp
Volume	Ref 6.2 cu.ft / Frz 2.4 cu.ft	Power Connection	NEMA 5-15P with 41" power cord
Finishing	White	Certification	CEC / ETL
Door finish	Panel ready	Energy star	Yes
Interface	Internal digital LED touch interface	Warranty	2 years parts & labor
Lighting	LED on top	Packaging dimensions and weight	W 22 7/16" H 72 7/16" D 22 9/16" Weight 139.0lbs
Refrigerator shelves	1 stationary + 3 height adjustable		
Refrigerator drawers	1 + 1 fresco drawer with separate temperature and humidity control		
Freezer compartment	3 drawers		
Door storage	1 bin with lid - 2 height adjustable open bins		
Settings	Super cool, Super freeze, Eco mode, Vacation mode		

SIDE	FRONT	TOP
		

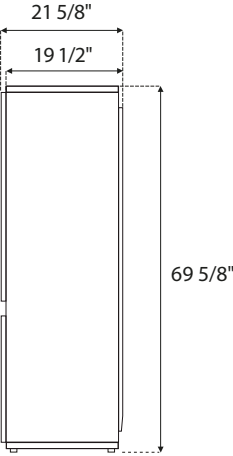
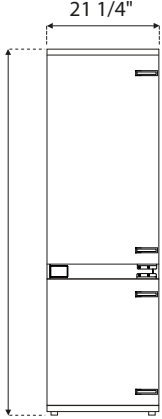
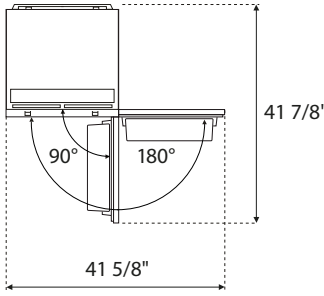

**COLUMNAS DE REFRIGERADOR**

BERTAZZONI	Código	Descripción	Color
	REF30RCBPNV	30" Refrigerator (Larder), reversible, panel ready	Acero
	<b>Especificaciones</b>		
Size	30 in	Refrigerator drawers	1 crisper + 3 Fresco drawers with separate temperature control
Cooling system	frost free	Door storage	1 height-adjustable gallon-sized bin + 2 stationary bins
User interface	LED touch control interface	Water filter	internal
Display functions	Door ajar alarm, Super Cool, Water filter replacement reminder, Water dispenser, Eco Mode, Vacation Mode, Sabbath Mode	Water supply pressure	25 psi to 80 psi
Lighting	LED side & top rail illumination	Sound rating	43 dbA
Door ajar alarm	yes	Certification	ADA Compliant, CEC, ETL
Door finishing	panel ready	DOE compliant	yes
Cabinet finishing	stainless steel back wall	<b>Technical specifications</b>	
Refrigerator net capacity	16.7 cu.ft	Sound rating	43
Refrigerator shelves	3 height-adjustable + 1 stationary	Electrical supply	115 V - 60 Hz - 112 W - 2 Amp
		Power connection	NEMA 5-15P with 90" power cord
		Energy consumption	325.0 kWh/yr

BERTAZZONI	Código	Descripción	Color
	REF24RCBPNV	24" Refrigerator (Larder), reversible, panel ready	Acero
	<b>Especificaciones</b>		
Size	24 in	Refrigerator drawers	1 crisper + 3 Fresco drawers with separate temperature control
Cooling system	frost free	Door storage	1 height-adjustable gallon-sized bin + 2 stationary bins
User interface	LED touch control interface	Water filter	internal
Display functions	Door ajar alarm, Super Cool, Water filter replacement reminder, Water dispenser, Eco Mode, Vacation Mode, Sabbath Mode	Water supply pressure	25 psi to 80 psi
Lighting	LED side & top rail illumination	Sound rating	41 dbA
Door ajar alarm	yes	Certification	ADA Compliant, CEC, ETL
Door finishing	panel ready	DOE compliant	yes
Cabinet finishing	stainless steel back wall	<b>Technical specifications</b>	
Refrigerator net capacity	12.5 cu.ft	Sound rating	41
Refrigerator shelves	3 height-adjustable + 1 stationary	Electrical supply	115 V - 60 Hz - 112 W - 2 Amp
		Power connection	NEMA 5-15P with 90" power cord
		Energy consumption	295.0 kWh/yr



**COLUMNAS DE CONGELADOR**

BERTAZZONI	Código	Descripción	Color
	REF18FCBIPLV	18" Freezer, left hinge, panel ready	Acero
	<b>Especificaciones</b>		
Size	18 in	Freezer drawers	4
Cooling system	frost free	Automatic ice maker	yes
User interface	LED touch control interface	Ice production capacity	3.9 lbs/24hrs
Display functions	Door ajar alarm, Super Freeze, Ice maker, Water filter replacement reminder, Eco mode, Vacation mode, Sabbath mode	Water filter	internal
		Water supply pressure	25 psi to 80 psi
		Sound rating	43 dbA
		Certification	ADA Compliant, CEC, ETL
Lighting	LED lights on sides and top	DOE compliant	yes
Door ajar alarm	yes	<b>Technical specifications</b>	
Door finishing	panel ready	Sound rating	43
Cabinet finishing	stainless steel back wall	Electrical supply	115 V - 60 Hz - 160 W - 2 Amp
Door storage	3 height-adjustable bins	Power connection	NEMA 5-15P with 90" power cord
Freezer net capacity	8.6 cu.ft <sup>3</sup>	Energy consumption	452.0 kWh/yr
Freezer shelves	3 height-adjustable + 1 stationary		

BERTAZZONI	Código	Descripción	Color
	REF24FCBIPNV	24" Freezer, reversible, panel ready	Acero
	<b>Especificaciones</b>		
Size	24 in	Freezer drawers	4
Cooling system	frost free	Automatic ice maker	yes
User interface	LED touch control interface	Ice production capacity	3.9 lbs/24hrs
Display functions	Door ajar alarm, Super Freeze, Ice maker, Water filter replacement alarm, Eco mode, Vacation mode, Sabbath mode	Water filter	yes
		Water supply pressure	25 psi to 80 psi
		Sound rating	41 dbA
		Certification	ADA Compliant, CEC, ETL
Lighting	LED lights on sides and top	DOE compliant	yes
Door ajar alarm	yes	<b>Technical specifications</b>	
Door finishing	panel ready	Sound rating	41
Cabinet finishing	stainless steel back wall	Electrical supply	115 V - 60 Hz - 160 W - 2 Amp
Freezer net capacity	12.4 cu.ft <sup>3</sup>	Power connection	NEMA 5-15P with 90" power cord
Freezer shelves	3 height-adjustable + 1 stationary	Energy consumption	511.0 kWh/yr

**COLUMNAS DE CONGELADOR**

BERTAZZONI	Código	Descripción	Color
	REF18WCBPRV	18" Wine Cellar, right hinges, panel ready	Acero
	Especificaciones		
Size	18 in	<b>Technical specifications</b>	
Cooling system	Three temperature zones	Electrical supply	115 V - 60 Hz - 1.5 A
User interface	LED touch control interface	Power rating	150W
Display functions	Entertainment mode, Light color selection, Sabbath mode, Showroom mode	Power connection	NEMA 5-15P with 90" power cord
		Energy consumption	226.0 kWh/yr
Lighting	LED lights interior illumination		
Door ajar alarm	yes		
Door finishing	panel ready		
Cabinet finishing	stainless steel back wall		
Wine racks	14 wooden shelves		
Bottle capacity	68 bottles		
Sound rating	41 dbA		
Certification	DOE Compliant, ETL		

BERTAZZONI	Código	Descripción	Color
	REF18WCBPLV	18" Wine Cellar, left hinges, panel ready	Acero
	Especificaciones		
Size	18 in	<b>Technical specifications</b>	
Cooling system	Three temperature zones	Electrical supply	115 V - 60 Hz - 1.5 A
User interface	LED touch control interface	Power rating	150W
Display functions	Entertainment mode, Light color selection, Sabbath mode, Showroom mode	Power connection	NEMA 5-15P with 90" power cord
		Energy consumption	226.0 kWh/yr
Lighting	LED lights interior illumination		
Door ajar alarm	yes		
Door finishing	panel ready		
Cabinet finishing	stainless steel back wall		
Wine racks	14 wooden shelves		
Bottle capacity	68 bottles		
Sound rating	41 dbA		
Certification	DOE Compliant, ETL		

BERTAZZONI	Código	Descripción	Color
	REF24WCBPNV	24" wine cellar, reversible, panel ready	Acero
	Especificaciones		
Size	24 in	<b>Technical specifications</b>	
Cooling system	Three temperature zones	Electrical supply	115 V - 60 Hz - 1.5 A
User interface	LED touch control interface	Power rating	150W
Display functions	Entertainment mode, Light color selection, Sabbath mode, Showroom mode	Power connection	NEMA 5-15P with 90" power cord
		Energy consumption	252.0 kWh/yr
Lighting	LED lights interior illumination		
Door ajar alarm	yes		
Door finishing	panel ready		
Cabinet finishing	stainless steel back wall		
Wine racks	14 wooden shelves		
Bottle capacity	100 bottles		
Sound rating	41 dbA		
Certification	DOE Compliant, ETL		

## ACCESORIOS

ACCESORIOS PARA REFRIGERADORES	
Código	Descripción
SP18CX	Steel panels for REF18FCBIP.V
SP30CX	Steel panels for REF30RCBPNV
SP24CX	Steel panels for columns RED24 (RC&FC)
MASHKCOL	Master Series handle kit for premium columns
PROHKCOL	Professional Series handle kit for premium columns
HERHKCOL	Heritage Series handle kit for premium columns
901667	Carbonio Panels for Column REF18FC
901665	Carbonio Panels for Column REF24RC/FC
901666	Carbonio Panels for Column REF30RC/FC
901664	Carbonio Panels for Column REF36RC
901669	Professional Titanium Handle for Columns

ACCESORIOS PARA CAVAS	
Código	Descripción
SP18WXV	Steel panels for REF18WCBPV
SP24WXV	Steel panels for REF24WCBPNV
901663	Carbonio Panels for Wine Column REF18W
901662	Carbonio Panels for Wine Column REF24W



**ESTUFAS 36" MASTER SERIES**

BERTAZZONI	Código	Descripción	Color
	MAS365GASXVLP	36" Master Series range - Gas oven - 5 aluminum burners (NG conversion kit included) LP	Acero
	MAS365GASNEV	36" Master Series Range - Gas oven - 5 aluminum burners	Negro
	MAS365GASBIV	36" Master Series Range - Gas oven - 5 aluminum burners	Blanco
<b>Especificaciones</b>			
<b>Worktop</b>		<b>Oven Cavity</b>	
Size	36 in	Oven configuration	single
Cooking zones	5	Oven fuel	gas
Gas zones	5	Oven type	fan assisted gas
Worktop type	gas	Oven broiler type	gas
Worktop design	stainless steel squared	Cooking modes	bake / broiler / convection bake
Worktop controls	Knobs	Oven volume	5.9 ft <sup>3</sup>
Knobs	solid metal	Oven convection system	dual horizontal fans
Burner type	aluminium	Oven controls	knobs / thermometer
Grates	cast iron	Inner oven door	triple
Continuous grating	yes	Removable inner glass	yes
Thermocouple safety device	yes	Cooling fan	yes
One-hand ignition	yes	Oven levels	7
Backguard	yes	Door hinge	soft-motion
Wok ring	yes	Wire-shelves	2 standard with handle
Simmer ring	yes	Tray	1 baking tray with grill trivet
<b>Cookinf zones</b>		Grill trivet for tray	yes
Power burners	1300 BTU/h - 19 000 BTU/h (1)	Oven lights	double lateral
Rapid burner	2500 BTU/h - 10 400 BTU/h (1)	<b>Bottom</b>	
Medium burner	1500 BTU/h - 5900 BTU/h (2)	Legs	stainless steel
Simmer burner	750 BTU/h - 3500 BTU/h (1)	<b>Technical specifications</b>	
		Absorbed current (A)	2.5 A with dedicated circuit
		Electrical supply	110V 60 Hz - 300W

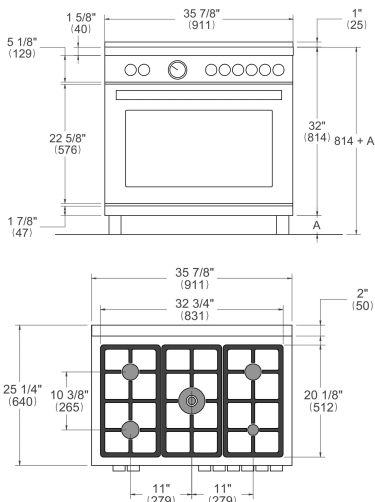

**ESTUFAS 36" PROFESSIONAL SERIES**

BERTAZZONI	Código	Descripción	Color
	PRO366BCFGMXT	36" Professional Series range - Gas oven - 6 brass burners	Acero
	PRO366BCFGMNET	36" Professional Series range - Gas oven - 6 brass burners	Negro
	PRO366BCFGMBIT	36" Professional Series range - Gas oven - 6 brass burners	Blanco
	PRO366BCFGMGIT	36" Professional Series range - Gas oven - 6 brass burners	Amarillo
	PRO366BCFGMART	36" Professional Series range - Gas oven - 6 brass burners	Naranja
	PRO366BCFGMROT	36" Professional Series range - Gas oven - 6 brass burners	Rojo
	PRO366BCFGMXTLP	36" Professional Series range - Gas oven - 6 brass burners LP Version	

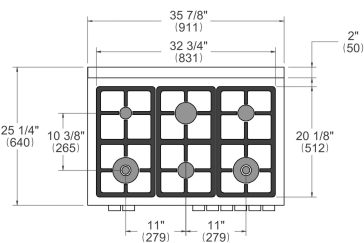
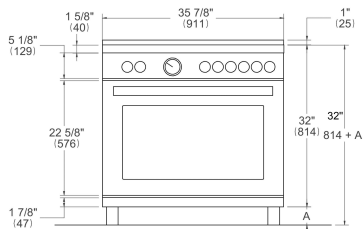

**Especificaciones**

Worktop		Oven Cavity	
Size	36 in	Oven configuration	single
Cooking zones	6	Oven fuel	gas
Gas zones	6 Burners	Oven type	fan assisted gas
Worktop type	gas	Oven broiler type	gas
Worktop design	stainless steel squared	Oven functions	bake / broiler / convection bake
Knobs	metal coated	Oven volume	5.9 ft <sup>3</sup>
Burner type	brass	Oven convection system	dual horizontal fans
Grates	cast iron	Inner oven door	triple
Continous grating	yes	Removable inner glass	yes
Thermocouple safety device	yes	Cooling fan	yes
One-hand ignition	yes	Oven levels	7
Backguard	yes	Door hinge	soft-close
Wok ring	yes	Sliding shelves	2 sets of telescopic glides
Simmer ring	yes	Wire-shelves	2 heavy duty
Cast iron griddle	yes	Tray	1 baking tray with grill trivet
		Grill trivet for tray	yes
		Oven lights	double lateral
Cookinf zones		Bottom	
Power burners	1300 BTU/h - 19 000 BTU/h (2)	Legs	stainless steel
Rapid burner	2500 BTU/h - 10 400 BTU/h (1)		
Medium burner	1500 BTU/h - 5900 BTU/h (2)	Technical specifications	
Simmer burner	900 BTU/h - 3500 BTU/h (1)	Absorbed current (A)	2.5 A with dedicated circuit
		Electrical supply	110V 60 Hz - 300W



**ESTUFAS 48" MASTER SERIES**

BERTAZZONI	Código	Descripción	Color
	MAS486GGASXVLP	48" Master Series range - Gas Oven - 6 aluminum (NG conversion kit included)	Acero Version LP
	MAS486GGASNEV	48" Master Series range - Gas Oven - 6 aluminum burners + griddle	Negro
	MAS486GGASBIV	48" Master Series range - Gas Oven - 6 aluminum	Blanco
<b>Especificaciones</b>			
<b>Worktop</b>		<b>Oven Cavity</b>	
Size	48 in	Oven configuration	double
Cooking zones	7	Oven fuel	gas
Gas zones	6 Burners	Oven convection system	dual horizontal fans
Griddle zones	electric	Main oven type	fan assisted gas
Worktop type	electric / gas	Main oven broiler type	gas
Worktop design	stainless steel squared	Main oven functions	bake / broiler / convection bake
Worktop controls	Knobs	Main oven volume	4.7 ft <sup>3</sup>
Knobs	solid metal	Auxiliary oven type	gas conventional
Burner type	aluminium	Auxiliary oven functions	bake
Grates	cast iron	Auxiliary oven volume	2.4 ft <sup>3</sup>
Continuous grating	yes	Oven control	knobs / thermometer
Thermocouple safety device	yes	Inner oven door	triple
One-hand ignition	yes	Removable inner glass	yes
Backguard	yes	Cooling fan	yes
Simmer ring	yes	Oven levels	7
<b>Cookinf zones</b>		Door hinge	soft-motion
Power burners	1300 BTU/h - 19 000 BTU/h (2)	Wire-shelves	2 each cavity
Rapid burner	2500 BTU/h - 10 400 BTU/h (1)	Tray	1 baking tray with grill trivet
Medium burner	1500 BTU/h - 5900 BTU/h (2)	Grill trivet for tray	yes
Simmer burner	750 BTU/h - 3500 BTU/h (1)	Oven lights	double lateral
Griddle power	1100 W	<b>Bottom</b>	
		Legs	stainless steel
<b>Technical specifications</b>			
		Absorbed current (A)	10 A with dedicated circuit
		Electrical supply	110V 60 Hz - 1200W

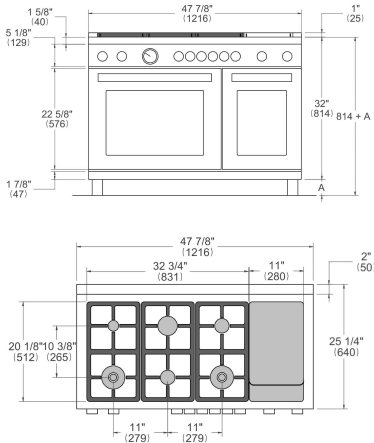

**ESTUFAS 48" PROFESSIONAL SERIES**

BERTAZZONI	Código	Descripción	Color	
	PRO486BTFGMXT	48" Professional Series range - Gas Oven - 6 brass burners + griddle	Acero	
	PRO486BTFGMNET	48" Professional Series range - Gas Oven - 6 brass burners + griddle	Negro	
	PRO486BTFGMBIT	48" Professional Series range - Gas Oven - 6 brass burners + griddle	Blanco	
	PRO486BTFGMGIT	48" Professional Series range - Gas Oven - 6 brass burners + griddle	Amarillo	
	PRO486BTFGMART	48" Professional Series range - Gas Oven - 6 brass burners + griddle	Naranja	
	PRO486BTFGMROT	48" Professional Series range - Gas Oven - 6 brass burners + griddle	Rojo	
	PRO486BTFGMXTLP	48" Professional Series range - Gas Oven - 6 brass burners + griddle LP Version		
	<b>Especificaciones</b>			
	<b>Worktop</b>		<b>Oven Cavity</b>	
	Size	48 in	Oven configuration	double
	Cooking zones	7	Oven fuel	gas
Gas zones	6 Burners	Oven type	gas conventional	
Griddle zones	electric	Oven convection system	dual horizontal fans	
Worktop type	electric / gas	Main oven type	fan assisted gas	
Worktop design	stainless steel squared	Main oven broiler type	gas	
Worktop controls	knobs	Main oven functions	bake / broiler / convection bake / defrosting	
Knobs	metal coated	Main oven volume	4.7 ft <sup>3</sup>	
Burner type	brass	Auxiliary oven type	gas conventional	
Grates	cast iron	Auxiliary oven broiler type	gas	
Continous grating	yes	Auxiliary oven functions	bake	
Thermocouple safety device	yes	Auxiliary oven volume	2.4 ft <sup>3</sup>	
One-hand ignition	yes	Oven controls	knobs / thermometer	
Backguard	yes	Inner oven door	triple	
Wok ring	yes	Removable inner glass	yes	
Simmer ring	yes	Cooling fan	yes	
<b>Cookinf zones</b>		Oven levels	7	
Power burners	1300 BTU/h - 19 000 BTU/h (2)	Food probe	yes	
Rapid burner	2500 BTU/h - 10 400 BTU/h (1)	Door hinge	soft-close	
Medium burner	1500 BTU/h - 5900 BTU/h (2)	Sliding shelves	2 sets of telescopic glides	
Simmer burner	750 BTU/h - 3500 BTU/h (1)	Wire-shelves	2 each cavity	
Griddle power	1100 W	Tray	1 baking tray with grill trivet	
Griddle dual control	yes	Grill trivet for tray	yes	
Griddle drip tray	yes	Oven lights	double lateral	
		<b>Bottom</b>		
		Legs	stainless steel	
		<b>Technical specifications</b>		
		Absorbed current (A)	10 A with dedicated circuit	
		Electrical supply	110 V 60 Hz - 1200W	

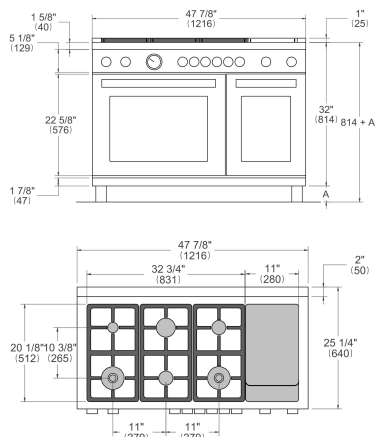



**ESTUFAS SERIE HERITAGE 36"**

BERTAZZONI	Código	Descripción	Color
	HER366BCFGMNET	36" Heritage Series range - Gas Oven - 6 brass burners	Negro
	HER366BCFGMXT	36" Heritage Series range - Gas Oven - 6 brass burners	Acero
	HER366BCFGMAVT	36" Heritage Series range - Gas Oven - 6 brass burners	Crema
<b>Especificaciones</b>			
<b>Worktop</b>		<b>Oven Cavity</b>	
Size	36 in	Oven configuration	single
Cooking zones	6	Oven fuel	gas
Gas zones	6 Burners	Oven type	fan assisted gas
Worktop type	gas	Oven broiler type	gas
Worktop design	stainless steel squared	Cooking modes	bake/broil/convection bake
Worktop controls	knobs	Oven volume	5.9 ft <sup>3</sup>
Knobs	solid metal	Oven convection system	dual horizontal fans
Burner type	brass	Oven controls	knobs/thermometer
Grates	cast iron	Inner oven door	triple
Continuous grating	yes	Removable inner glass	yes
Thermocouple safety device	yes	Cooling fan	yes
One-hand ignition	yes	Oven levels	7
Backguard	yes	Food probe	yes
Work adapter	yes	Door hinges	soft-close
Wok ring	yes	Sliding shelves	2 set of telescopic glides
Simmer ring	yes	Wire-shelves	2 heavy duty
Cast iron griddle	yes	Tray	1 baking tray with grill trivet
<b>Cooking zones</b>		Grill trivet for tray	yes
Power Burners	1300 BTU/h - 19 000 BTU/h (2)	Oven lights	double lateral
Rapid Burner	2500 BTU/h - 10 400 BTU/h (1)	<b>Bottom</b>	
Medium Burner	1500 BTU/h - 5900 BTU/h (2)	Legs	stainless steel
Simmer Burner	750 BTU/h - 3500 BTU/h (1)		
<b>Technical specifications</b>			
Absorbed current (A)	2.5 A with dedicated circuit		
Electrical supply	110V 60 Hz - 300W		

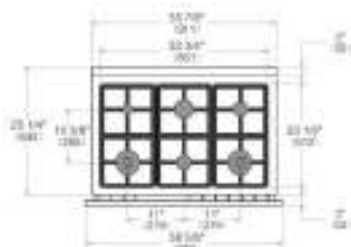
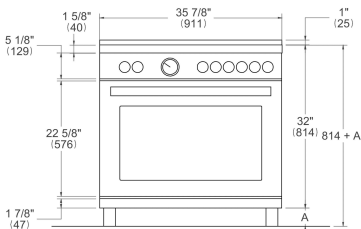

**CAMPANAS SERIE HERITAGE 36"**

BERTAZZONI	Código	Descripción	Color
	KC36HERTX	36" Canopy Hood Stainless	Acero
	KC36HERTAV	36" Canopy Hood Ivory	Crema mate
	KC36HERTNE	36" Canopy Hood Nero	Negro
<b>Especificaciones</b>			
<b>Worktop</b>		Lights	2 LED
Size	36 in	Hood finishing	stainless steel and matt or glossy color
<b>Hood</b>		Sound rating	1.3 - 8.6 Sones
Hood type	wallmount	Max extraction power	600 CFM
Hood control	electronic with buttons	<b>Technical specifications</b>	
Duct cover	included	Electrical supply	120 V - 60 Hz - 3.30 A
Motor	1	Power rating	400 W
Speed	3		
Filters type	baºe stainless steel		
<b>Motor para campana HERITAGE 36"</b>			
K36HERTX	Motor 600 CFMS		
<b>*Se debe cotizar Campana más Motor.</b>			









**ESTUFAS SERIE HERITAGE 48"**

BERTAZZONI	Código	Descripción	Color
	HER486BTFGMNET	48" Heritage Series range - Gas Oven - 6 brass burners + griddle	Negro
	HER486BTFGMXT	48" Heritage Series range - Gas Oven - 6 brass burners + griddle	Acero
	HER486BTFGMAVT	48" Heritage Series range - Gas Oven - 6 brass burners + griddle	Crema

Especificaciones			
Worktop		Oven Cavity	
Size	48 in	Oven configuration	double
Cooking zones	7	Oven fuel	gas
Gas zones	6 Burners	Oven type	gas conventional
Griddle zones	electric	Oven convection system	dual horizontal fans
Worktop type	electric / gas	Main oven type	fan assisted gas
Worktop design	stainless steel squared	Main oven broiler type	gas
Worktop controls	knobs	Main oven functions	bake/broiler/convection bake/defrosting
Knobs	solid metal	Main oven volume	4.7 ft <sup>3</sup>
Burner type	brass	Auxiliary oven type	gas conventional
Grates	cast iron	Auxiliary oven broiler type	gas
Continous grating	yes	Auxiliary oven functions	bake
Thermocouple safety device	yes	Auxiliary oven volume	2.4 ft <sup>3</sup>
One-hand ignition	yes	Oven controls	knobs/thermometer
Backguard	yes	Inner oven door	triple
Wok ring	yes	Removable inner glass	yes
Simmer ring	yes	Cooling fan	yes
		Oven levels	7
		Food probe	yes
		Door hinges	soft-close
		Sliding shelves	2 sets of telescopic glides
		Wire-shelves	2 each cavity
		Tray	1 baking tray with grill trivet
		Grill trivet for tray	yes
		Oven lights	double lateral

Cookinf zones	
Power burners	1300 BTU/h - 19 000 BTU/h (2)
Rapid burner	2500 BTU/h - 10 400 BTU/h (1)
Medium burner	1500 BTU/h - 5900 BTU/h (2)
Simmer burner	750 BTU/h - 3500 BTU/h (1)
Griddle power	1100 W
Griddle dual control	yes
Griddle drip tray	yes

Technical specifications	
Absorbed current (A)	10 A with dedicated circuit
Electrical supply	110V 60 Hz - 1200W

Bottom	
Legs	stainless steel

**CAMPANAS SERIE HERITAGE 48"**

BERTAZZONI	Código	Descripción	Color
	KC48HERTX	48" Canopy Hood Stainless	Acero
	KC48HERTAV	48" Canopy Hood Ivory	Crema mate
	KC48HERTNE	48" Canopy Hood Nero	Negro mate
<b>Especificaciones</b>			
<b>Worktop</b>		Lights	2 LED
Size	48 in	Hood finishing	stainless steel and matt or glossy color
<b>Hood</b>		Sound rating	1.3 - 8.6 Sones
Hood type	wallmount	Max extraction power	600 CFM
Hood control	electronic with buttons	<b>Technical specifications</b>	
Duct cover	included	Electrical supply	120 V - 60 Hz - 3.30 A
Motor	1	Power rating	400 W
Speed	3		
Filters type	baºe stainless steel		
<b>Motor para campana HERITAGE 48"</b>			
K48HERTX	Motor 600 CFMS		
<b>*Se debe de cotizar campana + motor.</b>			



**ACCESORIOS OPCIONALES ESTUFAS**

Código	Descripción
901309	Satinless Steel Grid SG36X (Works for rangetops and DB an QB Cooktops)
901472	Satinless Steel Grid CIG36 (Works for all ranges)

**DECOR SET PARA CAMPANA Y ESTUFA HERITAGE 36" - 48"**

Código	Descripción
DSHERTKHGO	Decor Set 1- Range & Hood Kit : Gold Finish
DSHERTKHPC	Decor Set 1- Range & Hood Kit : Polished Copper Finish
DSHERTKHSB	Decor Set 1- Range & Hood Kit : Matt Satin Black Finish



**DECOR SET PARA ESTUFAS MASTER 36" - 48"**

Código	Descripción
DSMASGKSG	10 x knobs in Gold
DSMASGKSB	10 x knobs in Black Nickel
DSMASHSG	2 x handle finials in Gold
DSMASHSB	2 x handle finials in nickel

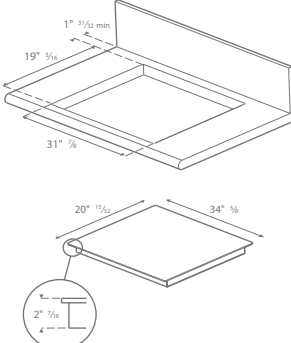

**PARRILLAS DE INDUCCIÓN PROFESSIONAL SERIES**

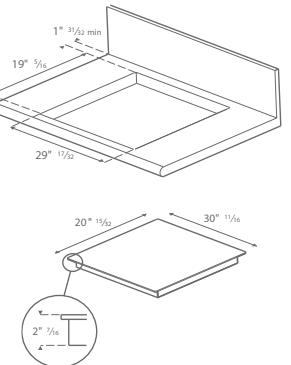
BERTAZZONI	Código	Descripción	
 	P365IAE	36" - 5 Induction Zones Cooktop Professional Series	
	Especificaciones		
Worktop		Cooking zones	
Size	36 in	Induction 2 bridge zones	yes
Cooking zones	5	Induction front left	(=8 3/4 in) 2 100 W - 3 700 W
Induction zones	5	Induction back left	(=8 3/4 in) 2 100 W - 3 700 W
Worktop type	induction	Induction center	(=12 in) 2 600 W - 5 500 W
Worktop design	ceramic glass bevelled	Induction front right	(=8 3/4 in) 2 100 W - 3 700 W
Worktop controls	touch controls	Induction back right	(=8 3/4 in) 2 100 W - 3 700 W
		Technical specifications	
		Electrical supply	208/240 V - 50/60 Hz - 48 A
		Power rating	11 100 W

BERTAZZONI	Código	Descripción	
 	P304IAE	30" - 4 Induction Zones Cooktop Professional Series	
	Especificaciones		
Worktop		Cooking zones	
Size	30 in	Induction front left	(=8 3/4 in) 2 100 W - 3 700 W
Cooking zones	4	Induction back left	(=8 3/4 in) 2 100 W - 3 700 W
Induction zones	4	Induction front right	(=9 1/4 in) 2 100 W - 3 700 W
Worktop type	induction	Induction back right	(=11 1/4 in) 2 600 W - 3 700 W
Worktop design	ceramic glass bevelled		
Worktop controls	touch controls		
		Technical specifications	
		Electrical supply	208/240 V - 50/60 Hz - 32 A
		Power rating	7 400 W



**PARRILLAS ENCIMERAS DE GAS BERTAZZONI**

BERTAZZONI	Código	Descripción	Color	
	P905Cprox	90cm Gas on steel Cooktop, 5 Brass Burners	Acero	
	Especificaciones			
	Worktop		Cooking zones	
	Size	90 cm	Front right	1 auxiliary 0.48 kW - 1.00 kW
	Worktop surface	stainless steel	Back right	1 rapid 1.05 kW - 3.00 kW
	Layout	5 burners	Center	1 wok dual 0.48 kW - 5.00 kW
	Worktop controls	knobs	Front left	1 semi-rapid 0.60 kW - 1.75 kW
	Knobs	metal	Back left	1 semi-rapid 0.60 kW - 1.75 kW
	Pan supports	cast iron	Technical specifications	
	Burner type	brass	Electrical requirements	220/240, 50/60 Hz, 1A, 1W
Work burner	5 kW dual			
Flame failure device	-			
One-hand ignition	-			
Standard accessories	-			

**PARRILLAS DE GAS**

BERTAZZONI	Código	Descripción	Color	
 	PROF486GRTBXT	48" Rangetop 6 Brass Burners + Griddle Professional Series	Acero	
	Especificaciones			
	Worktop		Cooking zones	
	Size	48 in	Griddle zones	electric
	Maintop	6 burners + stainless steel griddle with cover	Worktop type	electric/gas
	Burner power	2 power burners 19000 BTU 1 rapid burner 10400 BTU 2 medium burners 5900 BTU 1 simmer burner 3500 BTU	Worktop desing	stainless steel squared
			Knobs	solid metal
			Burner type	brass
	Ignition system	Electric with thermocouple safety device	Technical specifications	
	Grates	Cast iron	Electrical requirements	120 V - 60 Hz - 10 A
		Power rating	1100 W	

BERTAZZONI	Código	Descripción	Color	
 	MAST486GRTBXT	48" Rangetop 6 Brass Burners + Griddle Master Series	Acero	
	Especificaciones			
	Worktop		Cooking zones	
	Size	48 in	Griddle zones	electric
	Maintop	6 burners + stainless steel griddle with cover	Worktop type	electric/gas
	Burner power	2 power burners 19000 BTU 1 rapid burner 10400 BTU 2 medium burners 5900 BTU 1 simmer burner 3500 BTU	Worktop desing	stainless steel squared
			Knobs	solid metal
			Burner type	brass
	Ignition system	Electric with thermocouple safety device	Technical specifications	
	Grates	Cast iron	Electrical requirements	120 V - 60 Hz - 10 A
		Power rating	1100 W	





BERTAZZONI	Código	Descripción	Color
	PROF366RTBXT	36" Rangetop 6 Brass Burners Profesional Series	Acero
	Especificaciones		
Worktop		Cooking zones	6
Size	36 in	Griddle zones	electric
Maintop	6 burner	Worktop type	electric/gas
Burner power	2 power burners 19000 BTU 1 rapid burner 10400 BTU 2 medium burners 5900 BTU 1 simmer burner 3500 BTU	Worktop desing	stainless steel
		Knobs	solid metal
		Burner type	brass
Ignition system	Electric with thermocouple safety device	Technical specifications	
Grates	Cast iron	Electrical requirements	120 V - 60 Hz - 1 A
		Power rating	1 W

BERTAZZONI	Código	Descripción	Color
	MAST366RTBXT	36" Rangetop 6 Brass Burners Master Series	Acero
	Especificaciones		
Worktop		Cooking zones	6
Size	36 in	Griddle zones	electric
Maintop	6 burner	Worktop type	electric/gas
Burner power	2 power burners 19000 BTU 1 rapid burner 10400 BTU 2 medium burners 5900 BTU 1 simmer burner 3500 BTU	Worktop desing	stainless steel
		Knobs	solid metal
		Burner type	brass
Ignition system	Electric with thermocouple safety device	Technical specifications	
Grates	Cast iron	Electrical requirements	120 V - 60 Hz - 1 A
		Power rating	0.01 W



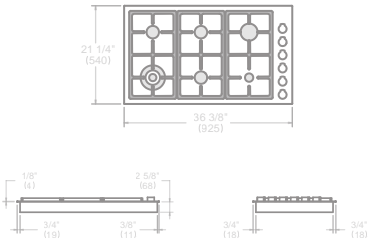

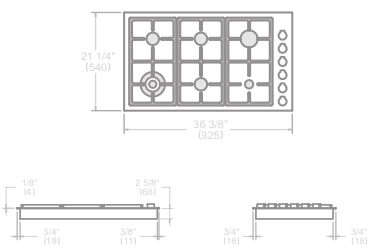

BERTAZZONI	Código	Descripción	Color
 	MAST366QBXT	36" Built-in cooktop master series	Acero
	Especificaciones		
Worktop		Cooking zones	6
Size	36 in	Griddle zones	electric
Maintop	6 burner	Worktop type	electric/gas
Burner power	1 power burners 17000 BTU 1 rapid burner 10400 BTU 3 medium burners 6000 BTU 1 simmer burner 3750 BTU	Worktop desing	stainless steel
		Knobs	solid metal
Ignition system	Electric with thermocouple safety device	Burner type	brass
		Technical specifications	
Grates	Cast iron	Electrical requirements	120 V - 60 Hz - 1 A
		Power rating	1 W

BERTAZZONI	Código	Descripción	Color
 	PROF366QBXT	36" Built-in cooktop professional series	Acero
	Especificaciones		
Worktop		Cooking zones	6
Size	36 in	Griddle zones	electric
Maintop	6 burner	Worktop type	electric/gas
Burner power	1 power burners 17000 BTU 1 rapid burner 10400 BTU 3 medium burners 6000 BTU 1 simmer burner 3750 BTU	Worktop desing	stainless steel
		Knobs	solid metal
Ignition system	Electric with thermocouple safety device	Burner type	brass
		Technical specifications	
Grates	Cast iron	Electrical requirements	120 V - 60 Hz - 1 A
		Power rating	0.01 W



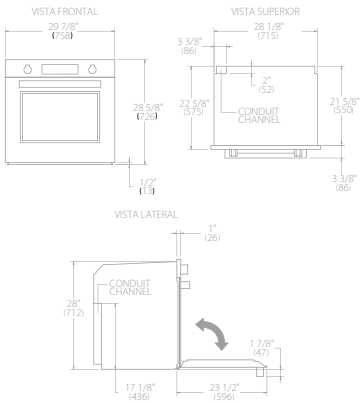

**HORNOS CONVECCIÓN 30"**

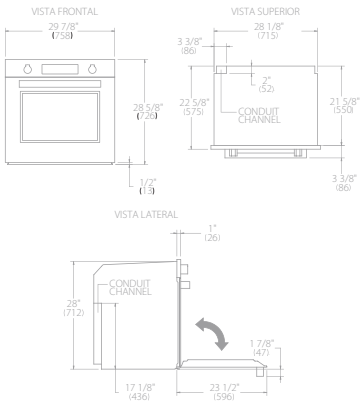
BERTAZZONI	Código	Descripción	Color
 	PROF30FSEXT	30" Single Convection Oven Top Version Profesional Series	Acero
	Especificaciones		
<b>Worktop</b>		Cavity finishing	pyrolytic grey enamel
Size	30 in	Oven handle	metal
Oven configuration	single	Cooling fan	yes
Oven fuel	electric	Oven levels	7
Oven type	self-clean	Timer	touch digital programmer
Oven broiler type	electric	Auto cooking modes	33 preset / with assistant
Oven functions	bake / broiler / convection / convection bake / convection broiler / defrosting / dehydrate / proofing / pyrolytic self clean / turbo / warming	Door hinge	soft-motion
Overall volume	4.10 ft <sup>3</sup>	Sliding shelves	1 full extension
		Wire-shelves	2 heavy gauge chromed
Oven convection system	dual diagonal with heating element	Tray	1 enamelled
		Grill trivet for tray	yes
Oven controls	knobs / touch LCD hi res display	Oven lights	double
Inner oven door	quadruple	Technical specifications	
Removable inner glass	yes	Electrical requirements	120/240 Vac - 60 Hz - 30 A
		Power rating	5400 W

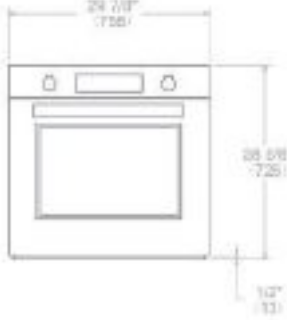
BERTAZZONI	Código	Descripción	Color
 	MAST30FSEXT	30" Single Convection Oven Top Version Master Series	Acero
	Especificaciones		
<b>Worktop</b>		Oven handle	metal
Size	30 in	Cooling fan	yes
Oven configuration	single	Oven levels	7
Oven fuel	electric	Timer	touch digital programmer
Oven type	self-clean	Door hinge	soft-close
Oven broiler type	electric	Wire-shelves	2 heavy gauge chromed
Oven functions	bake / broiler / convection / convection bake / convection broiler / defrosting / dehydrate / proofing / pyrolytic self clean / turbo / warming	Tray	1 enamelled
Overall volume	4.10 ft <sup>3</sup>	Grill trivet for tray	yes
		Oven lights	single
Oven convection system	dual diagonal with heating element	Technical specifications	
Oven controls	knobs / touch LED display	Electrical requirements	120/240 V - 60 Hz - 30 A
Inner oven door	quadruple	Power rating	5400 W
Removable inner glass	yes		
Cavity finishing	pyrolytic grey enamel		

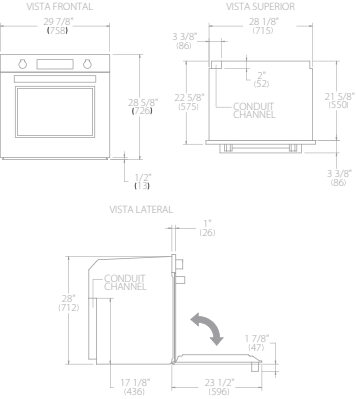
BERTAZZONI	Código	Descripción	Color
 	PROF30FSEXV	30" Single Convection Oven Value Version Profesional Series	Acero
	Especificaciones		
<b>Worktop</b>		Oven handle	metal
Size	30 in	Cooling fan	yes
Oven configuration	single	Oven levels	7
Oven fuel	electric	Timer	touch digital programmer
Oven type	self-clean	Door hinge	soft-motion
Oven broiler type	electric	Wire-shelves	1 flat / 1 shaped
Oven functions	bake / broil / convection / convection bake / convection broiler / defrosting / dehydrate / proofing / pyrolytic self clean / pizza / sabbath mode / warming	Tray	1 baking tray whit roasting trivet
Overall volume	4.10 ft <sup>3</sup>	Grill trivet for tray	yes
Oven convection system	dual diagonal with heating element	Oven lights	single
Oven controls	knobs / touch LED display	Technical specifications	
Inner oven door	quadruple	Electrical requirements	120/240 V - 60 Hz - 30 A
Removable inner glass	yes	Power rating	5400 W
Cavity finishing	pyrolytic grey enamel		

BERTAZZONI	Código	Descripción	Color
 	MAST30FSEXV	30" Single Convection Oven Value Version Master Series	Acero
	Especificaciones		
<b>Worktop</b>		Oven handle	metal
Size	30 in	Cooling fan	yes
Oven configuration	single	Oven levels	7
Oven fuel	electric	Timer	touch digital programmer
Oven type	self-clean	Door hinge	soft-motion
Oven broiler type	electric	Wire-shelves	2 heavy gauge chromed
Oven functions	bake / broil / convection / convection bake / convection broil / pizza / defrost / dehydrate / fast preheat / keep warm / light / proof / self clean / timer	Tray	1 enamelled
Overall volume	4.10 ft <sup>3</sup>	Grill trivet for tray	yes
Oven convection system	dual diagonal with heating element	Oven lights	single
Oven controls	knobs / touch LED display	Technical specifications	
Inner oven door	quadruple	Electrical requirements	120/240 V - 60 Hz - 30 A
Removable inner glass	yes	Power rating	5400 W
Cavity finishing	pyrolytic grey enamel		

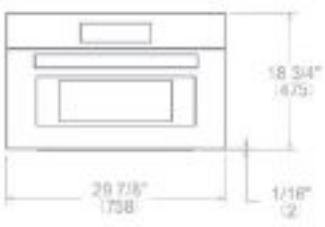
BERTAZZONI	Código	Descripción	Color
  	PROF30SOEX	30" Convection Speed Oven Profesional Series	Acero
	Especificaciones		
<b>Worktop</b>		Oven handle	metal
Size	30 in	Microwave power	200 / 400 / 600 / 800 / 1000
Oven configuration	single	Oven levels	2
Oven fuel	electric	Timer	yes
Oven type	self-clean	Door hinge	soft-motion
Oven broiler type	electric	Wire-shelves	1 flat / 1 shaped
Oven functions	broil / convection / microwave / convection broil / microwave whit broiler/ pizza / defrost by time / defrost by weight / light / popcorn / recipes / timer	Tray	1 glass
Overall volume	1.34 ft <sup>3</sup>	Grill trivet for tray	yes
Oven convection system	single whit ring heating element	Oven lights	single
Oven controls	touch LED display	Technical specifications	
Inner oven door	double	Electrical requirements	120/240 V - 60 Hz - 16 A
Removable inner glass	yes	Power rating	1500 W
Cavity finishing	stainless steel		

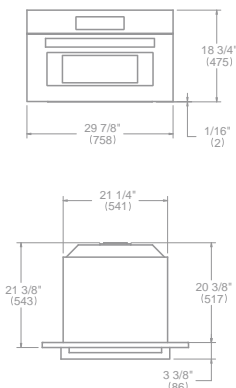
BERTAZZONI	Código	Descripción	Color
  	MAST30SOEX	30" Convection Speed Oven Master Series	Acero
	Especificaciones		
<b>Worktop</b>		Oven handle	metal
Size	30 in	Microwave power	200 / 400 / 600 / 800 / 1000
Oven configuration	single	Oven levels	2
Oven fuel	electric	Timer	yes
Oven type	self-clean	Door hinge	soft-motion
Oven broiler type	electric	Wire-shelves	1 flat / 1 shaped
Oven functions	broil / convection / microwave / convection broil / microwave whit broiler/ pizza / defrost by time / defrost by weight / light / popcorn / recipes / timer	Tray	1 glass
Overall volume	1.34 ft <sup>3</sup>	Grill trivet for tray	yes
Oven convection system	single whit ring heating element	Oven lights	single
Oven controls	touch LED display	Technical specifications	
Inner oven door	double	Electrical requirements	120/240 V - 60 Hz - 30 A
Removable inner glass	yes	Power rating	1500 W
Cavity finishing	stainless steel		

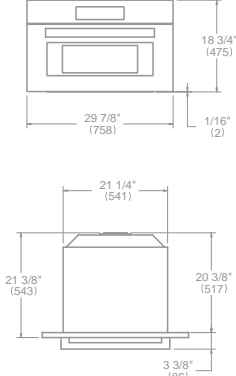
BERTAZZONI	Código	Descripción	Color
 	PROF30CSEX	30" Convection Steam Oven Profesional Series	Acero
	<b>Especificaciones</b>		
<b>Worktop</b>		Oven handle	metal
Size	30 in	Shelf levels	2
Oven configuration	single	Door hinges	soft-motion
Oven fuel	electric	Removable water tank	33.8 fl.oz
Oven type	combination electric		
Oven broiler type	convection and steam		
Oven broiler type	electric		
Oven functions	broil / convection / convection broil / convection steam / steam only / descale / light / recipes / reheat / sterilize / timer / water hardness / setting		
Overall volume	1.34 ft <sup>3</sup>	<b>Technical specifications</b>	
Oven convection system	1 fan	Electrical requirements	240 V - 60 Hz - 16 A
Oven controls	touch LED display	Power rating	3200 W
Inner oven door	double		
Removable inner glass	yes		
Cavity finishing	stainless steel		

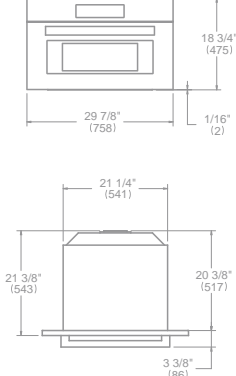
BERTAZZONI	Código	Descripción	Color
 	MAST30CSEX	30" Convection Steam Oven Master Series	Acero
	<b>Especificaciones</b>		
<b>Worktop</b>		Oven handle	metal
Size	30 in	Shelf levels	2
Oven configuration	single	Door hinges	soft-motion
Oven fuel	electric	Removable water tank	33.8 fl.oz
Oven type	combination electric		
Oven broiler type	convection and steam		
Oven broiler type	electric		
Oven functions	broil / convection / convection broil / convection steam / steam only / descale / light / recipes / reheat / sterilize / timer / water hardness / setting		
Overall volume	1.34 ft <sup>3</sup>	<b>Technical specifications</b>	
Oven convection system	1 fan	Electrical requirements	240 V - 60 Hz - 30 A
Oven controls	touch LED display	Power rating	3200 W
Inner oven door	double		
Removable inner glass	yes		
Cavity finishing	stainless steel		

**HORNO CONVECCIÓN 24"**

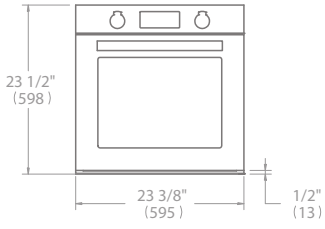
BERTAZZONI	Código	Descripción	Color
 	PROF24FSEXV	24" Electric Convection Oven Professional Series	Acero
	Especificaciones		
<b>Worktop</b>		Cavity finishing	black enamel
Size	24 in	Oven handle	metal
Oven configuration	Single	Cooling fan	yes
Oven fuel	Electric	Oven levels	5
Oven broiler type	Electric	Timer	touch digital programmer
Cooking modes	bake / bottom bake / broil / convection / convection bake / convection broil / defrosting dehydrate / fast preheat / oven light / pizza / proofing turbo / upper bake	Door hinges	soft-motion
		Wire-shelves	1 flat / 1 shaped
		Tray	1 baking tray with roasting trivet
Technical especifications			
Gross volume oven		2.70 ft <sup>3</sup>	
Oven convection system		single	
Oven controls		knobs / touch LED display	
Inner oven door		triple	
Removable inner glass		yes	
Electrical supply		120/240 V 60 Hz - 2800 W 208/240 V 60 Hz - 2100 W 16 Amp dedicated circuit	
Power rating		Bake: 2050 W / Broiler: 2400 W / Convection: 1800 W	
Power connection		metal conduit 59" power cord	
Certification		UL	

**MICROONDAS**

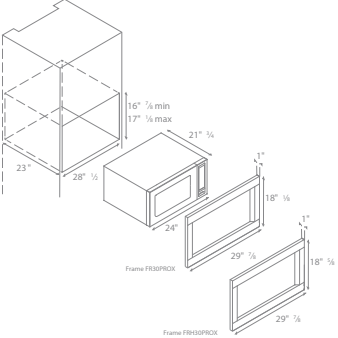
BERTAZZONI	Código	Descripción	Color
 	MO30STANE/16	30" Microwave Oven	Acero
	Especificaciones		
<b>Worktop</b>		Sensor reheat, defrost, cook	yes
Size	30 in	Clock/Timer	yes
Overall volume	2.00 ft <sup>3</sup>	Cook time function	yes
Cavity finishing	Enameled white	Child lock	yes
Microwave power levels	10 Levels	Turnspit	1 Ø 16
Preset cooking mode functions	yes	Technical especifications	
Multiple sequence cooking	4	Electrical requirements	120 V - 60 Hz - 10 A
		Power rating	1100 W

**TRIMS**

BERTAZZONI	Código	Descripción	Color
	FR30PROX	30" Built-in Trim for MO30STANE	Acero
	Especificaciones		
Size	30 in		
Type	Built-in Installation of MO30STANE 24" Microwave		
Finishing	stainless steel		



BERTAZZONI	Código	Descripción	Color
	PROF24SOEX	24" - Convection Speed Oven Professional Series	Acero
	Especificaciones		
Worktop		Grill trivet for tray	yes
Special functions	defrost by time / defrost by weight / light / popcorn / recipes timer	Turntable quantity	1 glass
Size	24 in		
Microwave type	combi-microwave		
Functions	broil / convection / microwave / convection broil microwave / microwave with broiler / pizza		
Total volume	1.34 ft <sup>3</sup>	Technical specifications	
Oven convection system	single	Electrical supply	240 V - 60 HZ - 3850 W / 16 Amp dedicated circuit Broiler: 1500 W / Convection: 1600 W
Oven controls	touch LED display	Power connection	NEMA 6-20P with 71" power cord
Auto cooking modes	yes	Certification	CETLUS
Inner oven door	double		
Removable inner glass	yes		
Cavity finishing	stainless steel		
Oven levels	2		
Microwave power levels	200 / 400 / 600 / 800 / 1000		
Clock/Timer	yes		
Tray	1 glass		

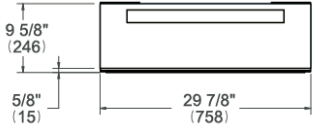

**CAJONES CALIENTES**

BERTAZZONI	Código	Descripción	Color
  	PROF30WDEX	30" Convection Warming Drawer	Acero
	Especificaciones		
Worktop		Technical specifications	
Size	30 in	Electrical supply	120 V - 60 Hz - 500 W 5 Amps
Design	Stainless steel	Power connection	NEMA 5-15P with 59" power cord
Volume	2.3 cu ft	Certification	CETLUS
Cavity finishing	Tempered glass bottom	Packaging dimensions and weight	W 26 3/8" H 13 1/2" D 32 3/4" 87.3 lbs
Temperature range	85 - 170 °F		

BERTAZZONI	Código	Descripción	Color
  	MAST30WDEX	30" Convection Warming Drawer	Acero
	Especificaciones		
Worktop		Technical specifications	
Size	30 in	Electrical supply	120 V - 60 Hz - 500 W 5 Amps
Design	Stainless steel	Power connection	NEMA 5-15P with 59" power cord
Oven Volume	2.3 cu ft	Certification	CETLUS
Cavity finishing	Tempered glass bottom	Packaging dimensions and weight	W 26 3/8" H 13 1/2" D 32 3/4" 87.3 lbs
Temperature range	85 - 170 °F		

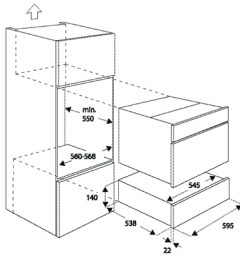
BERTAZZONI	Código	Descripción	Color
  	WD60PROX	24" Warming Drawer Professional Series	Acero
	Especificaciones		
Worktop		Technical specifications	
Size	24 in	Voltage and frequency	220/240 V - 50/60 Hz
Design	Stainless steel	Absorbed power (W)	400 W
Controls	push/pull with soft motion operation		
Equipment	inner rubber matt / thermostat light on/o°		
Carring capacity	25kg		
Max temperature	85°C		

**CAMPANA**

BERTAZZONI	Código	Descripción	Color	
	KIN36XV	36" - Insert Hood, 1 motors 560 CFM Professional Series	Acero	
	Especificaciones			
	Hood		Technical specifications	
	Size	36 in	Electrical supply	110 V - 60 Hz - 3.30 A
	Hood type	built-in	Power rating	410 W
	Hood control	electronic with buttons	Power connection	NEMA 5-15P with 59" power cord
	Motor	1	Certification	CEC, UL
	Speed	3 + booster		
	Filters type	aluminum mesh		
	Lights	2 LED		
Hood finishing	stainless steel			
Duct size	6" diameter			
Sound rating	1.5 - 6 Sones			
Max extraction power	560 CFM			
Accesorios				
901531	Charcoal Filters for Kin Hoods			
901532	Durable Charcoal Filters for Kin Hoods			
901575	Remote Control for Kin Hoods			

**LAVAVAJILLAS**

BERTAZZONI	Código	Descripción	Color	
	DW24T3IPV	24" - Dishwasher Tall Tub Panel Ready, Professional Series	Acero	
	Especificaciones			
	Worktop			
	Size	24 in	Delayed start	yes
	Place setting	15	Lighting	floor projection status light
	Controls	concealed multi-button	Drying system	PowerDry Plus
	Interior finish	stainless steel	Overflow protection device	yes
	User interface	LED display	Filter system	triple stage metal filter
	Spray arms	3	Certification	CEC, NSF, UL
	Number of racks	3	Technical specifications	
Cutlery basket	sliding	Electrical supply	120 V - 60 Hz - 12 A	
Wash cycle	6 - auto, crystal and china, pots and pans, quick, regular, rinse and hold	Power rating	1400 W	
Wash Options	7 - accel, extra dry, delay start, 3 half load modes, sanitize, scrub, stealth	Energy consumption	234 kWh	
Accesorios				
HK24PRODWX	Handle Kit for 24 Dishwasher Professional series			
HK24MASDWX	Handle Kit for 24 Dishwasher Master Series			
HK24HERDWX	Handle Kit for 24 Dishwasher Heritage Series			
901661	Carbonio Panels for dishwasher DW24T			
901668	Professional Titanium Handle for Dishwasher			



📍 Oficinas Corporativas Artexa  
Cañón Grande 7720, Col. La Estanzuela  
Monterrey, N.L. 64984  
T: (81) 8625 5000 | info@artexa.com

📍 Artexa Experience & Design Center Mexico City  
Homero 1433 Mezzanine, Col. Polanco II Secc.  
Delegación Miguel Hidalgo, Ciudad de México 11540  
T: (81) 8625 5090 / 5091 | citas@artexa.com

📍 Taller de Arquitectura Artexa  
Ruben Darío 1533 Piso 6B  
Col. Providencia Sección 4  
C.P. 44639 Guadalajara, Jalisco.

🌐 [www.artexa.com](http://www.artexa.com)

📘 [ArtexaMx](#)

📷 [artexamx](#)

📌 [Artexamex](#)

📺 [ArtexaMx](#)

🎵 [artexamx](#)

🌐 [Artexa-mexico](#)