



SWIM SPA COLLECTION



JACUZZI® BRAND IS AN ICON

Legendary for performance, reliability and ease of use, we set the standard by which all hydrotherapy is measured. While imitation may be the sincerest form of flattery, only 60 years of innovation can produce swim spa designs made to the demanding standards of the Jacuzzi® Brand.





Swim Spas



Hot Tubs



Commercial



Bathtubs



Showers



Saunas

Jacuzzi® Brand products are manufactured in 5 countries, enjoyed in more than 100 countries worldwide, and employ thousands of people around the world. Representing decades of innovation, design, performance and ease of use, the Jacuzzi® Brand is trusted by millions of customers globally.

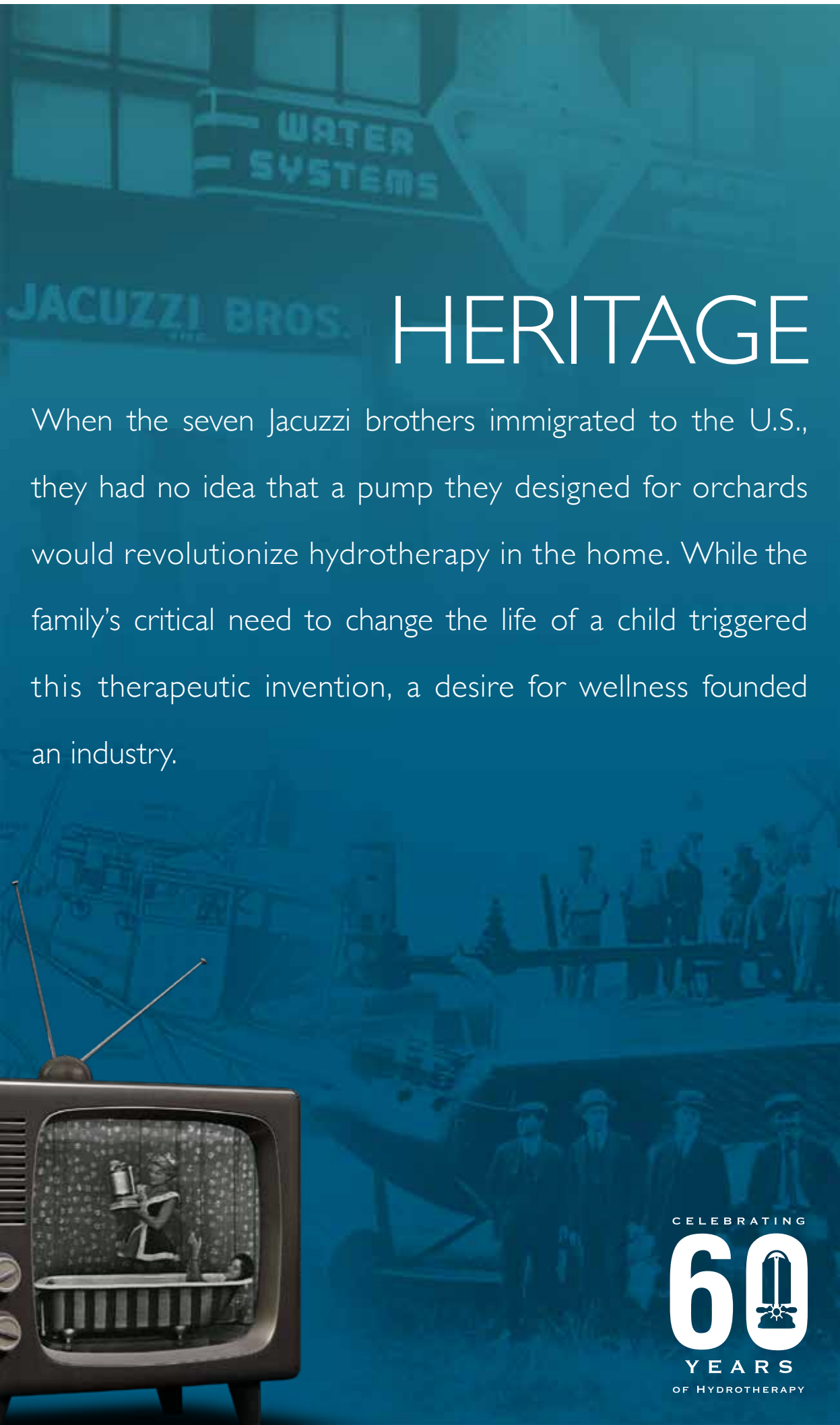

HERITAGE

When the seven Jacuzzi brothers immigrated to the U.S., they had no idea that a pump they designed for orchards would revolutionize hydrotherapy in the home. While the family's critical need to change the life of a child triggered this therapeutic invention, a desire for wellness founded an industry.

CELEBRATING

60

YEARS

OF HYDROTHERAPY



The Jacuzzi family departs Italy for the United States and transforms the aviation and agriculture industries.

When Ken Jacuzzi, age 2, is diagnosed with rheumatoid arthritis, his father invents a portable hydrotherapy pump to provide pain-relieving hydrotherapy.



Jacuzzi soon became a household name thanks in part to repeated appearances on the national daytime television show, *Queen for a Day*, which boasted 20 million viewers. The Jacuzzi® Brand became an overnight sensation.

Through the years, the Jacuzzi® Brand has been awarded more than 700 patents, laying our foundation for unmatched hydrotherapy and leading to breakthroughs in jet engineering, design, and the technology.



With a foundation in health and wellness and a dedication to research and innovation, Jacuzzi continues to develop products that improve the lives of both high-performance athletes and everyday people while leading the industry as the most recognized brand in the world.

PERFORMANCE

Jacuzzi® premium products support the needs of high endurance athletes and teams who are committed to maintaining and improving their quality of life, both during and beyond their active careers through the power of hydrotherapy. Whether you're a professional athlete or a weekend warrior, Jacuzzi® products increase your ability to train, recover, relax and perform, harnessing water's natural ability to heal the mind, body and soul.

The Jacuzzi® Brand proudly partners with endurance athletes and professional teams around the world.



JANET EVANS
Olympian and World Cup Champion
Freestyle Swimmer



MIKE ERUZIONE
Captain of the Gold Medal-Winning
1980 Winter Olympic Hockey Team



AMY PURDY
Paralympic Snowboarder



TRACE WORTHINGTON
2X Olympian and U.S. Ski and
Snowboard Hall of Famer



MELISSA STOCKWELL
Paralympian and Former U.S. Army
Officer



MATT GREVERS
4X Olympic Gold Medalist and
3X World Champion Swimmer



JOEY MANTIA
Olympian and World Champion
Speed Skater



THURL BAILEY
Retired NBA Player and Inspirational
Speaker



STEVE NYMAN
Olympian and World Cup Ski Racer



TIM JITLOFF
2X Olympian and U.S. Ski Team
Member



KIMBERLEY MORRISON
Triathlete and Ironman Champion



JASON LINDSAY
Professional Trainer



CYDNEY CLANTON
LPGA Pro



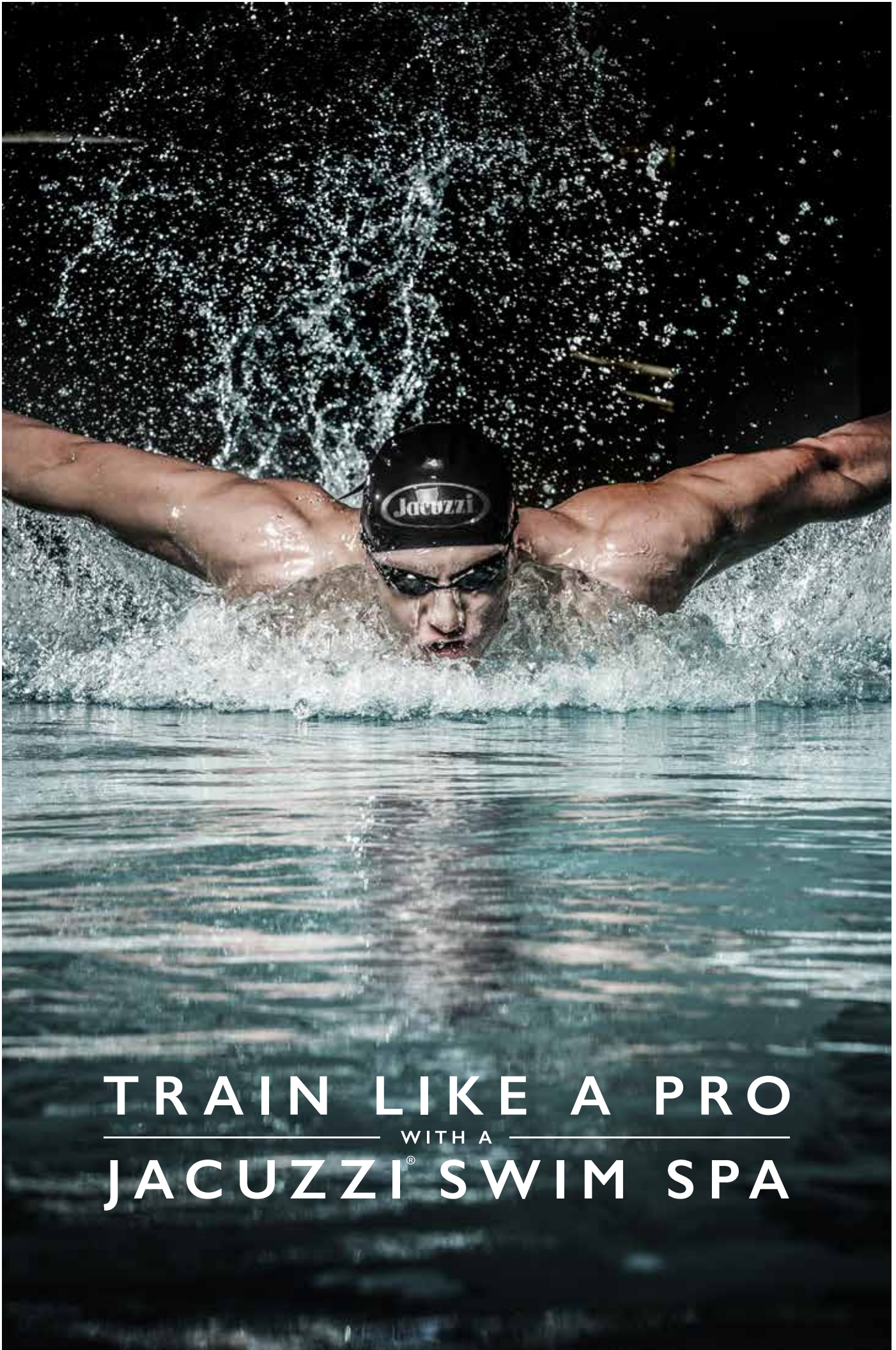

TRAIN LIKE A PRO
WITH A
JACUZZI® SWIM SPA

PRECISION SWIM

The best high-performance swim experience combines the latest aquatic technology with the expertise of Jacuzzi® PowerPro® Jets for a predictable swim.

BALANCED SWIM JETS ■

Adjustable flow of the swim jets produces consistently smooth water simultaneously, so that you can maintain a steady swim without being pushed out of your swim lane.

REFLECTIVE HIPS ■

A unique shell design incorporates hips to stop reflective waves, so you can always enjoy the perfect swim.

FLOW RETURN SUCTIONS ■

Suctions towards the back of the swim spa pull the flow of water for a more predictable current.

STEADYSWIM™ BUOYANCY JET



A unique buoyancy jet combines just the right amount of air with an extremely predictable current to help elevate you into the proper body position so you can focus on perfecting your stroke.

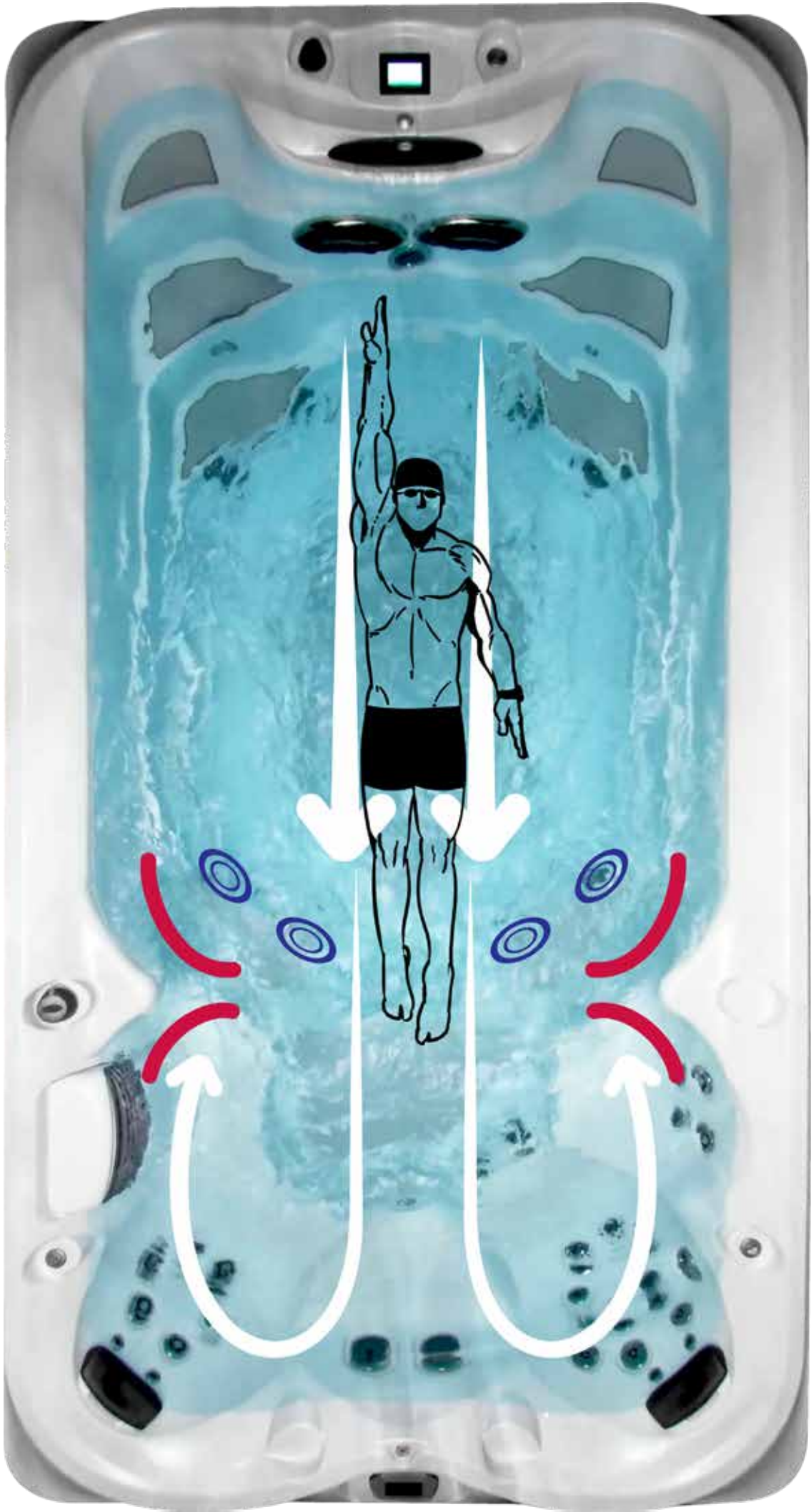

PRECISION SWIM

HYDROMASSAGE

Through the combination of versatile PowerPro® Jets, and our ergonomically designed seats, our products deliver an adjustable high-flow, low-pressure hydromassage and a powerful swim experience.

ANTHROPOMETRIC DIMENSIONS

By studying the anthropometric dimensions of the 5th percentile of females and 95th percentile of males, we can design hydromassage based on the average dimensions of 90% of the population to deliver a personalized massage.

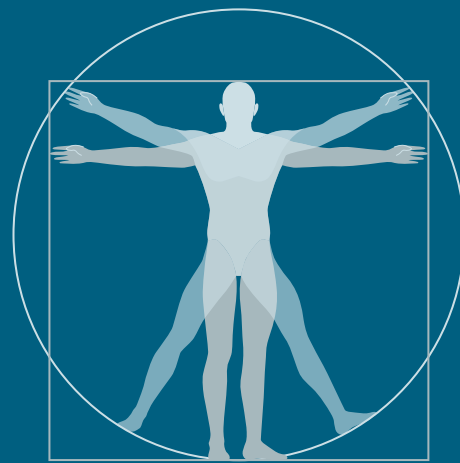

MUSCLE STRUCTURE
JET CONFIGURATION

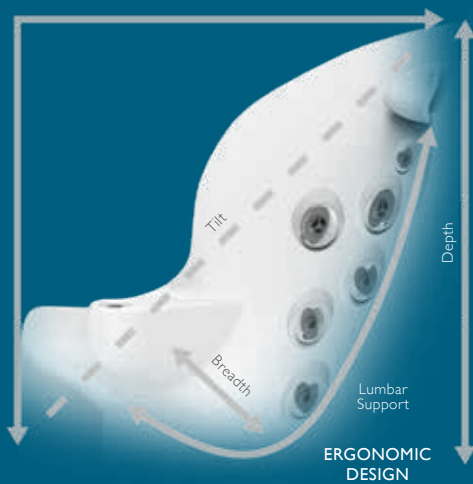

ERGONOMIC SEATING

Seats designed to follow the contours of the body and recessed jets placed to perfectly match the muscle structure of the human form delivers a comfortable, premium hydromassage experience for most body types.

COMPLETE BALANCE

Using the Aqualibrium® Formula, each jet is individually calibrated to deliver the perfect balance of air and water, then precisely paired with the exact pump-to-jet ratio needed to ensure a balanced experience in each and every seat.

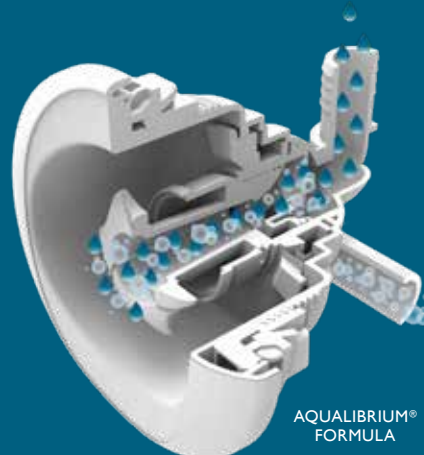

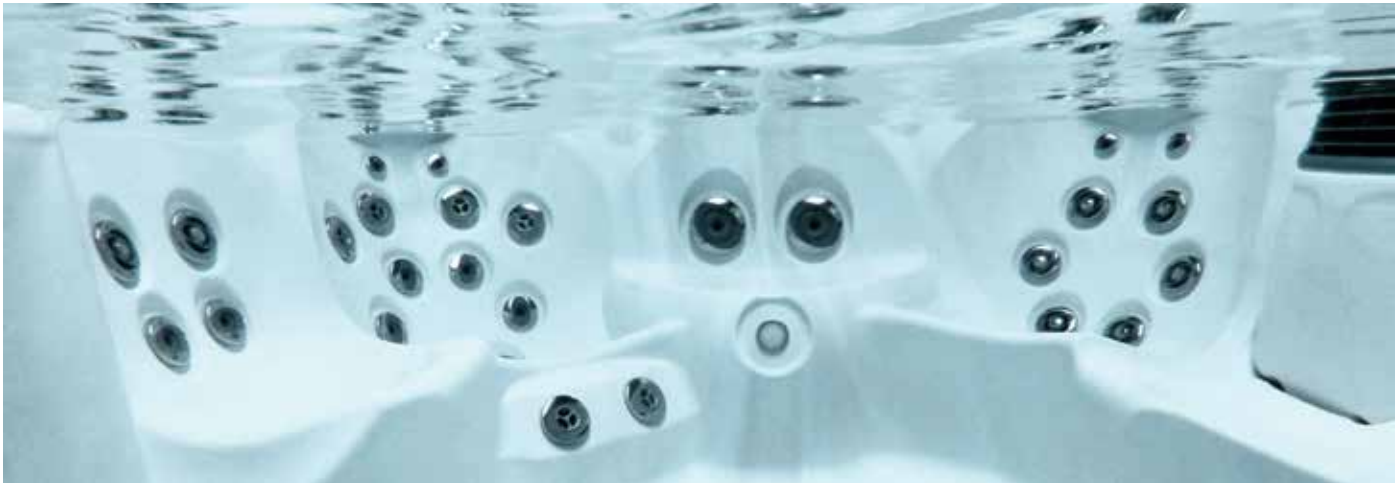

Jacuzzi® Swim Spas feature four seats designed to follow the contours of the body. Adjustable pillows and recessed PowerPro® jets placed to perfectly match key muscles used to swim deliver a comfortable, premium hydromassage experience.



HYDROMASSAGE



RX JET THERAPY SEAT



Targeting common swim muscles, the spinning RX jet seat delivers comforting **relief to the back and neck** utilizing the highest performance hydromassage the Jacuzzi® Brand offers.



FX THERAPY SEAT



Alleviating swimmer's soreness in the **neck, shoulders and back**, the full coverage massage seats delivers a deep, adjustable, rifling, spiral stream of air and water.

CLEAN WATER

We put the choice between chlorine or bromine systems with the power of UV-C technology.

CLEARRAY® UV-C TECHNOLOGY

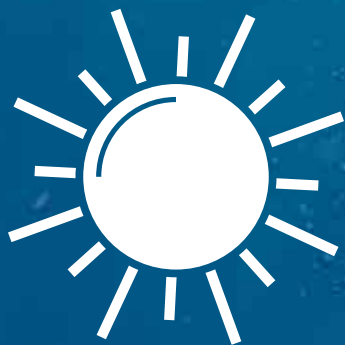

Nature-inspired technology neutralizes pathogens



Provides a soft, silky feel to the water



Same technology used in bottled drinking water, aquariums, and hospitals

Sophisticated yet simple, our water management system is truly designed for ease of use and exceptional performance. Utilizing **CLEARRAY®** technology and multi-stage filtration, Jacuzzi® Brand technology makes it easy to maintain clean and clear water.





MULTI-STAGE FILTRATION PROCESS

Hydromassage Pump

Dedicated filtration cycles on hydrotherapy pump

Surface Skimmer Weir Door/ ProCatch™ Bag

Cleans surface, trapping floating and large debris for easy removal

Two 60 Sq. Ft. Pleated Cartridge

Removes large and small particles, giving you the cleanest water possible



CLEARRAY® UV-C TECHNOLOGY

Instantly clarifies the water:

- Nature-inspired ultraviolet light to neutralize pathogens in the water
- UV-C Technology has been used in the bottling and beverage industry, municipal water plants, hospitals, aquariums and more for years
- Neutralizes 99.9% of water-borne pathogens

CLEAN WATER



CLEARRAY® PRO₃TECT™ AUTOMATIC OXIDIZER (OPTIONAL)

Part of the CLEARARRAY® Water Management System, CLEARARRAY® PRO₃TECT™ supports a hands-free approach to water care for clean, clear water.

- Designed to work with CLEARARRAY® UV-C technology, automatically oxidizing impurities in the water
- This genuine Jacuzzi® part is specifically calibrated to work with the filtration system in your swim spa
- Upgrade any new PowerPro® or PowerActive™ swim spa to include a factory-installed CLEARARRAY® PRO₃TECT™ System

QUALITY

Jacuzzi® Swim Spas are designed for reliability, both inside and out. We believe that quality is only as good as the people, processes and parts behind the products. That's why our products are exceptionally engineered with the best materials to ensure a superior product.



ENERGY EFFICIENT ENGINEERING

The combination of a strong shell, foam insulation, SmartSeal® insulation, insulated floor and fully-adjustable venting help boost eco-efficiency.

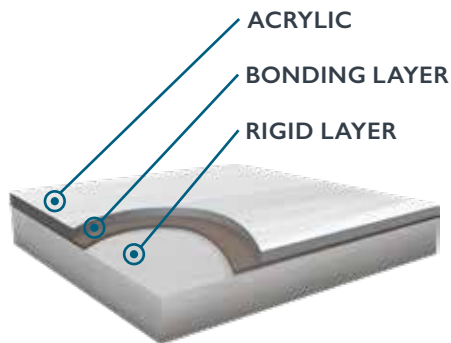

PROFUSION™ SHELL

Three layers of material for a strong, scratch-resistant shell



FOAM INSULATION

An air, moisture, and sound barrier adding structural integrity to pipes



SMARTSEAL® TECHNOLOGY

Heat-reflecting insulation made for the coldest winters.

Reflective Hips

Shell design helps stop reflective waves for consistently smoother water

PowerPro® Jets

Adjustable high-flow, low pressure hydromassage

Superior ProLast™ Covers

Custom fit to lock in heat and improve energy efficiency and safety

Programmable Filtration

Efficient self-cleaning technology filters more water in less time

ProFusion™ Shell

Three layers for a strong, scratch-resistant shell

Galvanized Steel Frame

Designed for durability and increased structural support

Superior Foam Insulation

Retains heat, absorbs noise, and supports plumbing

Durable ProPolymer™ Base

Impervious to nature and moisture, and makes installation easy

QUALITY

INNOVATION

Bring the traditional gym workout into the backyard year-round with the versatility of a swim spa. From low-impact current resistance to ergonomically-designed therapy seats, you can create the perfect swim experience for any skill level.



WATERWATCH™ FITNESS TRACKING TOOL

The only swim watch made specifically for swim spas



TRACK AND ANALYZE RESULTS

- Monitor your performance (calories, distance, laps, interval times)
- Track heart rate with vibration feedback
- Measure fitness progress in real-time



IN-HOME GUIDANCE

- Water-proof guidance on your wrist
- Set goals and upload to a computer
- Work out in the convenience of home



COMPREHENSIVE FITNESS ALTERNATIVE

- Compete against others worldwide
- Use for swim and resistance training
- Designed for all fitness levels



POWERPRO[®]

COLLECTION





POWERPRO®

SWIM SPA COLLECTION

FEATURES:

- WaterWatch™ Accessory
- ProEndure™ Cabinetry
- Swim Selector Control
- ProTouch™ Control
- PowerPro® Jets
- PowerPro® DX Swim Blade
- SteadySwim™ Buoyancy Jet
- CLEARRAY® UV-C System
- Multi-stage filtration
- Quick Drain System
- Soft Stride mat
- Illuminated Waterfall
- Premium LED Lighting
- Adjustable Headrests
- Status Indicator Light
- Exterior Running Lights

OPTIONAL FEATURES:

- CLEARRAY® PRO₃TECT™ Ozone Generator
- 60 Amp GFCI With Sub-Panel Box
- Auxiliary Heater By-Pass Loop
- Solid State Frame Only - No Cabinet
- Rowing Kit
- 48" Exercise Bar
- Aquatic Fitness Package



PERFORMANCE

- Adjustable PowerPro® DX swim blades for every level, from beginners to triathletes
- SteadySwim™ buoyancy jet keeps swimmers aligned by elevating you into the proper body position
- An unprecedented 4 - 4Hp pumps produce a powerful velocity of water for premium swim blade and hydrotherapy performance



DESIGN

- A unique SmoothSwim™ shell design incorporates hips in the shell to stop reflective waves and keep you in your swim lane
- An exclusive swim selector control near the swim blades let you adjust your experience at the touch of a button, from swim current speed to preprogrammed workout mode
- Return suctions located at the opposite end of swim blades eliminate turbulence, producing a conveyor belt-like swim system for a smoother swim



EASE OF USE

- Soft Stride mats allow you to enter and exit the swim spa safely
- Stunning, durable, synthetic wood cabinetry with an at-a-glance status indicator light that changes colors when your swim spa needs attention
- Swim rails are always within reach

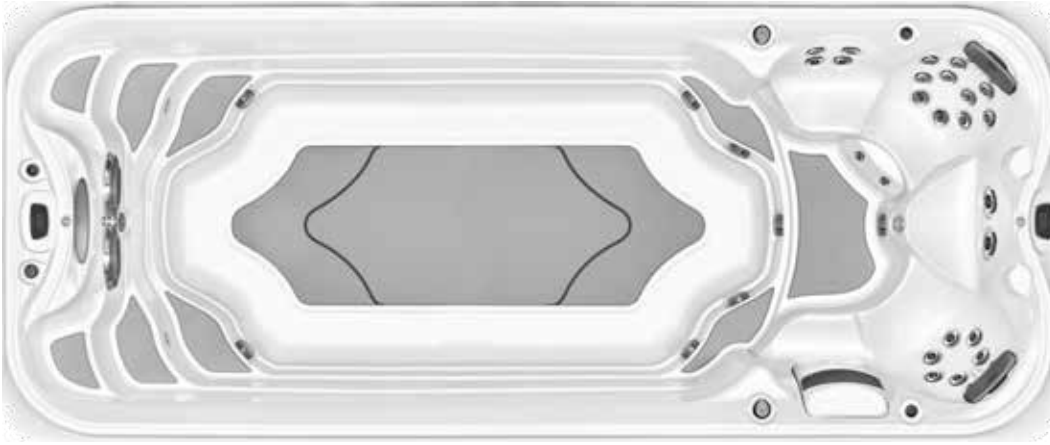

UNIT COST:
\$ 40,995 US

J-19 Power Pro™

DIMENSIONS *

222 in x 93 in x 53 in
 564 cm x 236 cm x 135 cm

USABLE SWIM AREA

148 in
 376 cm

DRY WEIGHT

3,028 lbs.
 1,374 kg.

TOTAL FILLED WEIGHT

22,948 lbs.
 10,412 kg.

AVERAGE SPA VOLUME

2,378 US gallons
 9,038 liters

PUMP 1

4HP/2SPD/12/1A (NA)
 3HP/2SPD/10/3A (EU/UK/AUS/NZ)

PUMP 2

4HP/2SPD/10/3.5A (NA)
 3HP/2SPD/8.6/2.8A (EU/UK/AUS/NZ)

PUMP 3

4HP/2SPD/10/3.5A (NA)
 3HP/2SPD/8.6/2.8A (EU/UK/AUS/NZ)

PUMP 4

4HP/2SPD/10/3.5A (NA)
 3HP/2SPD/8.6/2.8A (EU/UK/AUS/NZ)



UNIT COST:
\$ 35,795 US

J-16 Power Pro™

DIMENSIONS *

186 in x 93 in x 53 in
 472 cm x 236 cm x 135 cm

USABLE SWIM AREA

112 in
 284 cm

DRY WEIGHT

2,560 lbs.
 1,162 kg.

TOTAL FILLED WEIGHT

19,394 lbs.
 8,799 kg.

AVERAGE SPA VOLUME

2,010 US gallons
 7,638 liters

PUMP 1

4HP/2SPD/12/1A (NA)
 3HP/2SPD/10/3A (EU/UK/AUS/NZ)

PUMP 2

4HP/2SPD/10/3.5A (NA)
 3HP/2SPD/8.6/2.8A (EU/UK/AUS/NZ)

PUMP 3

4HP/2SPD/10/3.5A (NA)
 3HP/2SPD/8.6/2.8A (EU/UK/AUS/NZ)

PUMP 4

4HP/2SPD/10/3.5A (NA)
 3HP/2SPD/8.6/2.8A (EU/UK/AUS/NZ)

ACRYLIC OPTIONS



Porcelain Platinum Silver Pearl

CABINETRY COLORS

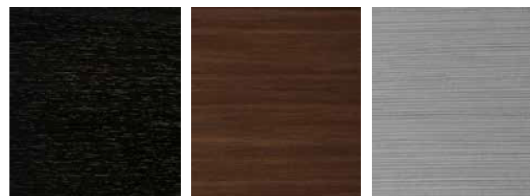

Smoked Ebony Modern Hardwood Brushed Gray

PROLAST™ COLORS

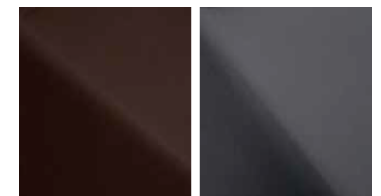

Walnut Gray

*All swim spa dimensions are shown in: L x W x H.

POWERACTIVE™ COLLECTION





POWERACTIVE™

SWIM SPA COLLECTION

FEATURES:

- WaterWatch™ Accessory
- ProEndure™ Cabinetry
- ProTouch™ Control
- PowerPro® Jets
- PowerPro® AX Jet
- SteadySwim™ Buoyancy Jet
- CLEARRAY® UV-C System
- Multi-stage filtration
- Quick Drain System
- Soft Stride mat
- Illuminated Waterfall
- Premium LED Lighting
- Adjustable Headrests
- Status Indicator Light
- Exterior Running Lights

OPTIONAL FEATURES:

- CLEARRAY® PRO₃TECT™ Ozone Generator
- 50 Amp GFCI With Sub-Panel Box
- Auxiliary Heater By-Pass Loop
- Solid State Frame Only - No Cabinet
- Rowing Kit
- 48" Exercise Bar
- Aquatic Fitness Package



PERFORMANCE

- PowerPro® AX jets deliver a smooth, spacious current for in-place swimming
- SteadySwim™ buoyancy jet keeps swimmers aligned by elevating you into the proper body position
- Together, a 4Hp and 5Hp pump produce a strong velocity of water for quality swim current and hydrotherapy performance



DESIGN

- A unique SmoothSwim™ shell design stops reflective waves, so you can always enjoy the perfect swim
- A ProTouch™ control lets you turn on your swim jets and adjust your hydrotherapy experience at the tap touch of a button
- Return suction located at the opposite end of swim jets eliminate turbulence, producing a conveyor belt-like swim system for a smoother swim



EASE OF USE

- Soft Stride mats allow customer to enter and exit the swim spa safely
- Stunning, durable, synthetic wood cabinetry with an at-a-glance status indicator light that changes colors when your swim spa needs attention
- Swim rails are always within reach

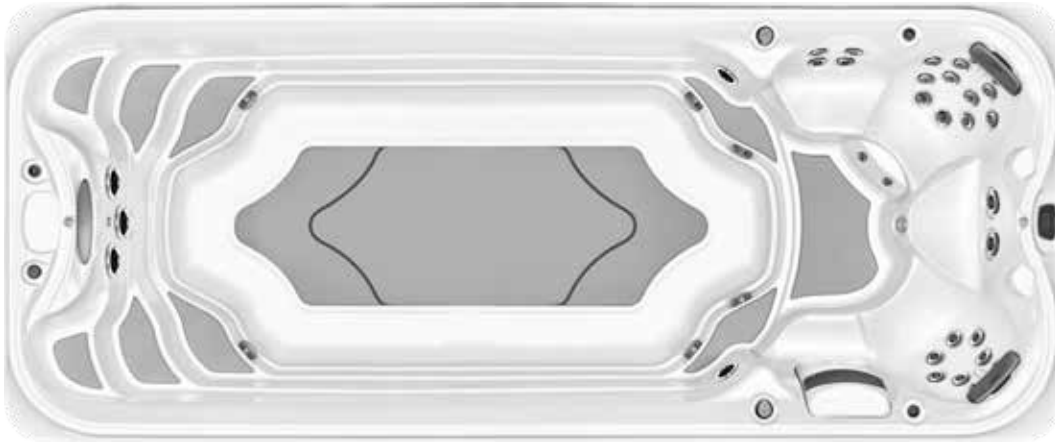

UNIT COST:
\$ 34,995 US

J-19 Power Active™

DIMENSIONS *

222 in x 93 in x 53 in
 564 cm x 236 cm x 135 cm

USABLE SWIM AREA

148 in
 376 cm

DRY WEIGHT

3,028 lbs.
 1,374 kg.

TOTAL FILLED WEIGHT

22,948 lbs.
 10,412 kg

AVERAGE SPA VOLUME

2,378 US gallons
 9,038 liters

PUMP 1

4HP/2SPD/12/1A (NA)
 3HP/2SPD/10/3A (EU/UK/AUS/NZ)

PUMP 2

5HP/1SPD/15A (NA)
 4HP/1SPD/12.7A (EU/UK/AUS/NZ)



UNIT COST:
\$ 29,895 US

J-16™

DIMENSIONS *

186 in x 93 in x 53 in
 472 cm x 236 cm x 135 cm

USABLE SWIM AREA

112 in
 284 cm

DRY WEIGHT

2,560 lbs.
 1,162 kg.

TOTAL FILLED WEIGHT

19,394 lbs.
 8,799 kg.

AVERAGE SPA VOLUME

2,010 US gallons
 7,638 liters

PUMP 1

4HP/2SPD/12/1A (NA)
 3HP/2SPD/10/3A (EU/UK/AUS/NZ)

PUMP 2

5HP/1SPD/15A (NA)
 4HP/1SPD/12.7A (EU/UK/AUS/NZ)

ACRYLIC OPTIONS



Porcelain Platinum Silver Pearl

CABINETRY COLORS

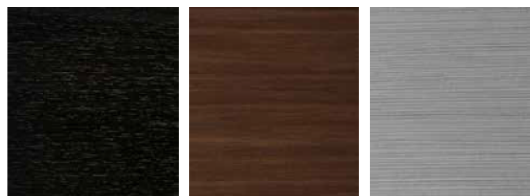

Smoked Ebony Modern Hardwood Brushed Gray

PROLAST™ COLORS

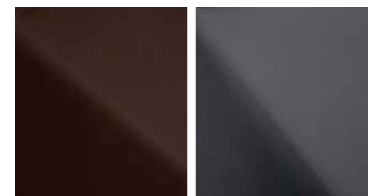

Walnut Gray

*All swim spa dimensions are shown in: L x W x H.

ACCESSORIES



FLOATING COVER WITH TIE DOWNS

Keep your swim spa warm and ready for use, prevent unwanted debris, and conserve energy with a secure floating cover with tie downs. To be used in conjunction with the Alaskan safety cover.



4-TIER AQUA STEP

Made with long-lasting, weather-resistant materials, steps that match your Jacuzzi® Swim Spa make it easy to enter and exit the water.

FITNESS OPTIONS



AQUA-ROWING KIT

A combination of stainless steel oars and rubber bands attach to swivel anchors allowing you to accomplish the full rowing motion. This is an excellent upper body and abdominal workout.



AQUA FITNESS PACKAGE

The addition of this fitness package turns any swim spa into an aquatic universal gym. The resistance bands add another dimension to your workout and can be used anywhere in your swim spa within the exercise or swim tank area.

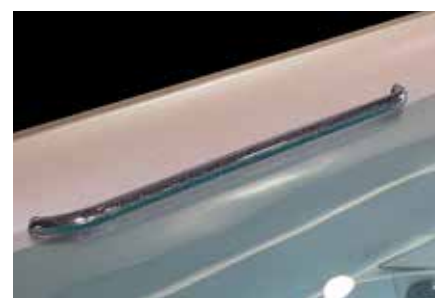

48" EXERCISE BARS

The addition of this wall mounted option allows you to use the swim spa for any rehabilitation or just provide balance when completing aquatic fitness programs.



Jacuzzi® Swim Spas are engineered to be the most energy efficient swim spa in the world. Offering the perfect alternative to a traditional swimming pool, swim spas are the perfect way to swim, workout, or just have fun all year long.



Cañon Grande 7720
Col. La Estanzuela
Monterrey, N.L. 64984

T. (81) 8625 5000
info@artexa.com

**Artexa Experience
& Desing Center Mexico City**

Homero 1433 Mezzanine
Col. Polanco II Secc.,
Delegación Miguel Hidalgo,
Ciudad de México 115440
citas@artexa.com